



# SOLUCIONES DE COMUNICACIÓN VISUAL

2026

ALUMINIUM PROFILE SYSTEMS



Monday to Thursday:  
8:30h to 14h and 15h to 18h  
Friday: 8:30h to 14:30h



[www.modular-signs.net](http://www.modular-signs.net)  
[export@modular-signs.net](mailto:export@modular-signs.net)



Teléfono  
**+34 968 105 373**



Av. de España, 14  
30562 Ceutí (Murcia)  
Spain

# Product Range

## SOFT TEXTILE PROFILES

SlimTEX XPO: Modular stand system with soft textile,  
PVC flexface or rigid sheet | P.6

SlimTEX 3D: soft textile for structures | P.10

SlimTEX: Soft textile for textile decoration, with sewn tape | P.12

Q|TEX: Soft textile for textile/canvas decoration | P.20

## PVC FLEXFACE PROFILES

LUMI-SIGN: Flex face signs, clip tension | P.24

LUMI-GRIP: Flex face signs, front insertion | P.26

ECOFLEX: Flex face frames, strip tension | P.30

WIND: Profiles for suspended advertising | P.34

## ACRYLIC FACE PROFILES

ECONOBOX: Acrylic lightboxes | P.38

ECONOCLIP: Acrylic lightboxes | P.40

FLAT PROFILES: Acrylic lightboxes | P.42

Sheet frame profiles | P.44

## CHANNEL LETTER

Stand-off brackets for letters | P.43

Contour profiles for acrylic letters | P.43

H profile for acrylic | P.43

## FRAME PROFILES

Standard aluminium profiles | P.46

Connectors for aluminium frame construction | P.46

## WAYFINDING SIGNAGE

GRAFOLIGHT SLALOM: Curved aluminium slats | P.50

GRAFOLIGHT ELITE: Aluminium slats and directories | P.52





# Soft textile profiles

# SLIM.TEX XPO

SOFT TEXTILE PROFILES FOR STANDS

*Slim.tex XPO is a profile system that allows the use of textile with silicone, bead-tensioned canvas and also rigid panels.*

*This makes it an extremely flexible system with infinite possibilities and applications.*

*The standard modules -sold as kits- are assembled without tools in very little time, for stands, photocalls, furniture, interior partitions, totems, changing rooms for pop-up stores and many other structures, with or without illumination.*

*The same bar profile is used to manufacture custom frames for interior use with textile, exterior use with tensioned canvas, suspended illuminated ceilings, wall cladding, with or without insulation, etc.*

## Slimtex XPO

### SLIMTEX XPO 65 PROFILE (P3X-65N6)

Profile for LED-illuminated frame.

Assembly with 4 P3X-00EQ corner brackets.

Edgelit or backlit. Depth: 65 mm.

Profile P3X-65N6

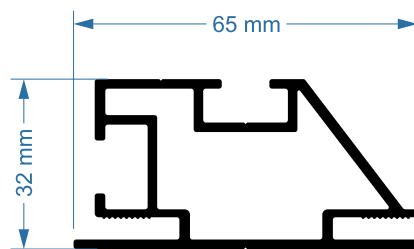

Assembly with 3mm rigid panel front

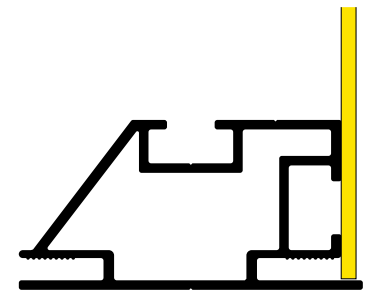

Assembly 2 textile sides with silicone

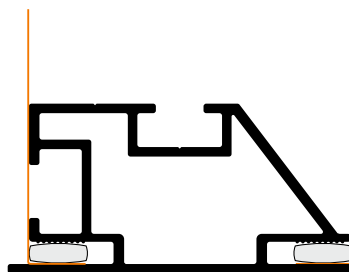

Assembly with Ecoflex tension strip and flex face

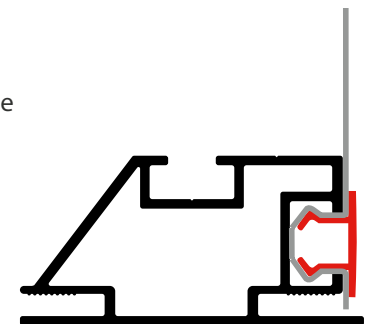

Assembly 1 textile side with backlit LED.

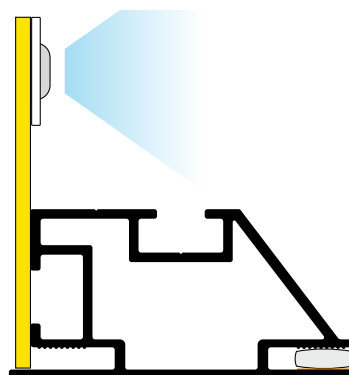

RECOMMENDED LED

BACKLIT

Backlit strip (20 cm between lines)

Assembly 1 textile side with perimeter LED

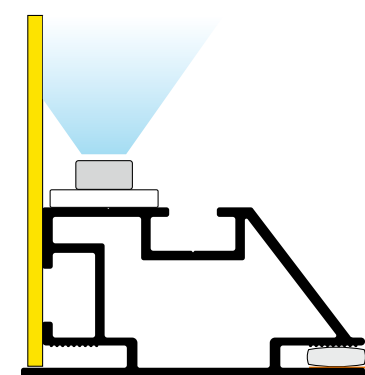

RECOMMENDED LED

EDGELIT

Strip ICTPR050 (< 130 cm wide)

# SLIM.TEX XPO

SOFT TEXTILE PROFILES FOR STANDS

## ISlimtex XPO

WIDTH **100**  
cm

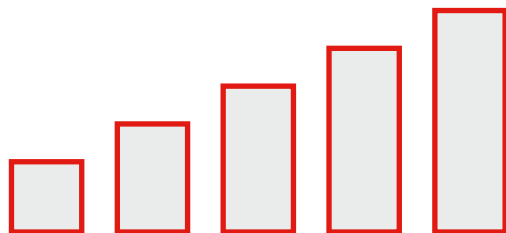

HEIGHT

300 cm	P3X-1030
250 cm	P3X-1025
200 cm	P3X-1020
150 cm	P3X-1015
100 cm	P3X-1010

WIDTH **90**  
cm

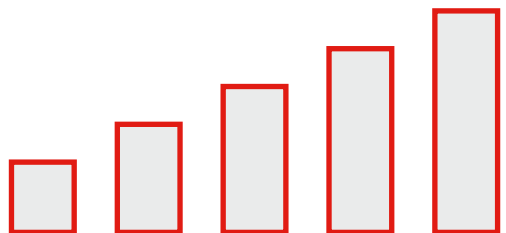

HEIGHT

300 cm	P3X-0930
250 cm	P3X-0925
200 cm	P3X-0920
150 cm	P3X-0915
100 cm	P3X-0910

WIDTH **50**  
cm

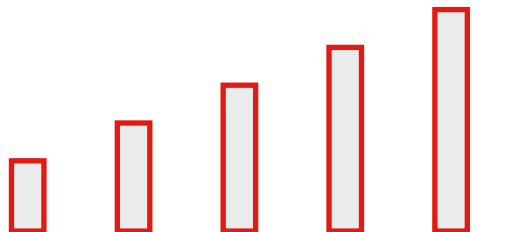

HEIGHT

300 cm	P3X-0530
250 cm	P3X-0525
200 cm	P3X-0520
150 cm	P3X-0515
100 cm	P3X-0510

### STANDARD FRAMES SLIMTEX XPO 65 KIT

Code	Description	Sales unit
P3X-0510	SLIMTEX XPO 65, module 50 x 100 cm in kit	unit
P3X-0515	SLIMTEX XPO 65, module 50 x 150 cm in kit	unit
P3X-0520	SLIMTEX XPO 65, module 50 x 200 cm in kit	unit
P3X-0525	SLIMTEX XPO 65, module 50 x 250 cm in kit	unit
P3X-0530	SLIMTEX XPO 65, module 50 x 300 cm in kit	unit
P3X-0910	SLIMTEX XPO 65, module 90 x 100 cm in kit	unit
P3X-0915	SLIMTEX XPO 65, module 90 x 150 cm in kit	unit
P3X-0920	SLIMTEX XPO 65, module 90 x 200 cm in kit	unit
P3X-0925	SLIMTEX XPO 65, module 90 x 250 cm in kit	unit
P3X-0930	SLIMTEX XPO 65, module 90 x 300 cm in kit	unit
P3X-1010	SLIMTEX XPO 65, module 100 x 100 cm in kit	unit
P3X-1015	SLIMTEX XPO 65, module 100 x 150 cm in kit	unit
P3X-1020	SLIMTEX XPO 65, module 100 x 200 cm in kit	unit
P3X-1025	SLIMTEX XPO 65, module 100 x 250 cm in kit	unit
P3X-1030	SLIMTEX XPO 65, module 100 x 300 cm in kit	unit
P3X-2015	SLIMTEX XPO 65, module 200 x 150 cm in kit	unit
P3X-2020	SLIMTEX XPO 65, module 200 x 200 cm in kit	unit
P3X-2025	SLIMTEX XPO 65, module 200 x 250 cm in kit	unit
P3X-2030	SLIMTEX XPO 65, module 200 x 300 cm in kit	unit
P3X-2525	SLIMTEX XPO 65, module 250 x 250 cm in kit	unit
P3X-2530	SLIMTEX XPO 65, module 250 x 300 cm in kit	unit
P3X-3030	SLIMTEX XPO 65, module 300 x 300 cm in kit	unit

#### RECOMMENDED LED

BACKLIT	EDGELIT
X6-20, X6-30	Strip ICTPB500 (< 130 cm wide)
Backlit strip	

\* Kit modules include 4 P3X-00EQ brackets and 4 profiles mitre-cut and machined with inter-module connection holes every 125 mm, and bracket locking holes. Assembly with Allen key.

# SLIM.TEX XPO

## SOFT TEXTILE PROFILES FOR STANDS

### SLIMTEX XPO 65 COMPONENTS

Code	Description	Sales unit
P3X-65N3	Slimtex XPO 65, frame profile / mill aluminium	bar 3.03 m
P3X-00EQ	Slimtex XPO, frame corner bracket	unit
P3X-23N3	Slimtex XPO, crossbar profile, 20x30x1.5 mm, mill aluminium	bar 3.03 m
P3X-00MT	Slimtex XPO, crossbar fixing clamp	unit
P3X-PTUN	Slimtex XPO, parallel module connection plate	unit
ZFE00067	M12x80 mm screw, for module connection	unit
ZFE00068	M12 nut, for module connection	unit
P3X-E090	Slimtex XPO, 90° bracket for corner module connection	unit
P3X-M610	Slimtex XPO, M6 mounting screw, for P3X-E090	unit
P3-EQ000	Reinforcement / wall fixing bracket, galvanised	unit
PTOT380G	Base plate 380 x 55 x 4 mm grey lacquered steel, with fasteners	unit
PTOT500G	Base plate 500 x 110 x 5 mm grey lacquered steel, with fasteners	unit
PT72500P	Reinforcement L 72 mm for base plate, grey lacquered	unit
PT72065P	Intermediate base supplement, grey lacquered	unit
P7-30121	ECOFLEX, 2-bolt plate 15x80mm (longitudinal joint)	unit
PPE6C603	Extension plate for XPO profile (use with 2x P7-30121)	unit
P3X-L65P	Slimtex XPO, PVC "L" Profile 65x65 mm / 2.5 m	bar 2.5 m
P3-CANSU	Eyebolt kit for M10 suspension + M10x45 screw + washers	unit
P3-SIL10	Slimtex, silicone tension tape, 10 m	roll 10 m
P3-SIL50	Slimtex, silicone tension tape, 50 m	roll 50 m
P3-ADH10	Slimtex, TEXTape adhesive tension tape, 10 m	roll 10 m
P3-ADH50	Slimtex, TEXTape adhesive tension tape, 50 m	roll 50 m

### SUSPENDED SATELLITES WITH SLIMTEX XPO

The XPO profile allows building truss-suspended satellites for stands, single or double-sided. Profile P3-050N0 is used for corner finishing (page 58).

- Easy to assemble and disassemble.
- Option for custom kit delivery.
- For non illuminated .



# SLIM.TEX XPO

SOFT TEXTILE PROFILES FOR STANDS

**P3X-65N6**

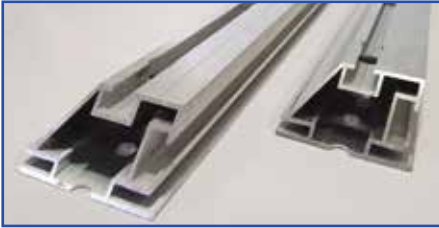

**P3X-00EQ**



**P3X-23N6**



**P3X-M610**



**P3X-E090**

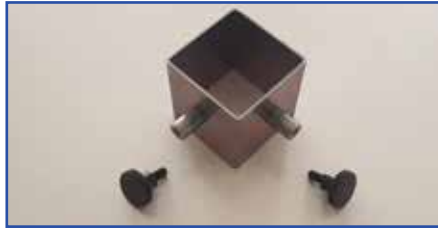

**P3X-00MT**



**P3X-PTUN**



**ZFE00067**



**ZFE00068**



**P3X-P090**



**P7-30121**



**P3X-P00T**



**P3-EQ000**



**PTOT500G**



**P3X-L65P**



**P3-ADH10 / 50**

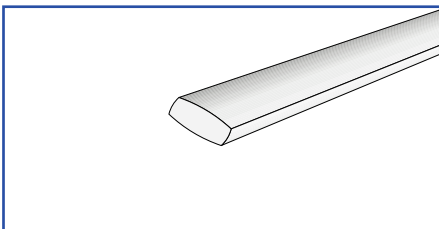

**PT72500P**



**P3-SIL10 / 50**

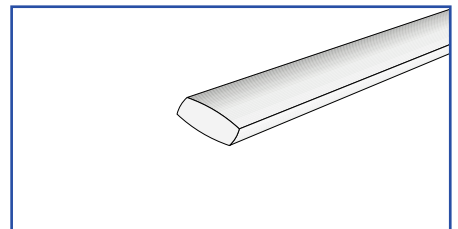

**P3-CANSU**



**PT72065P**



**PPE6C603**



# SLIM.TEX 3D

SOFT TEXTILE PROFILES FOR STANDS

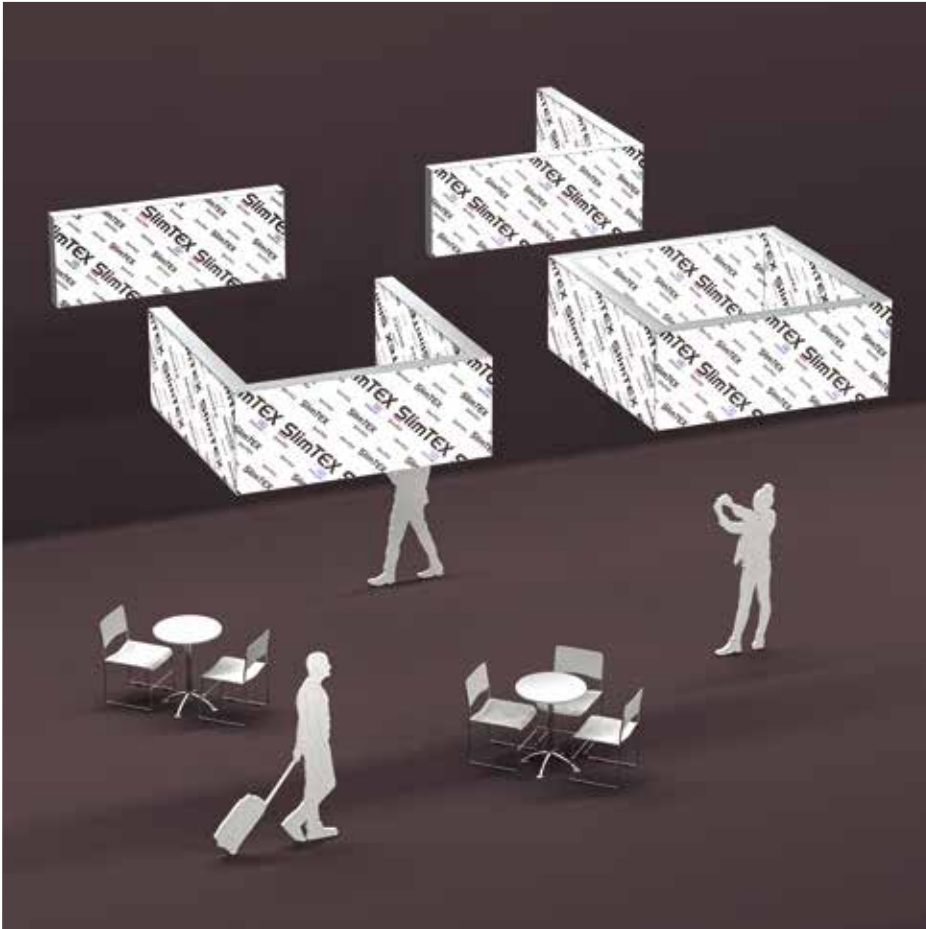

Slimtex S150



Slimtex S210



Corner bracket  
P321E090

## 3D STRUCTURES WITH SLIMTEX S150

The S150 profile, together with the S210 corner profile, allows building three-dimensional totems and double sided truss-suspended satellites for stands, illuminated or not.

- Easy to transport, assemble and disassemble. Reusable.
- Optional custom kit delivery.
- Can include exterior or interior illumination (double-sided).
- Illumination with HO perimeter strip (ICTPMxxx).
- Uniform illumination up to 4 meters height.
- 4 x 90° brackets per corner (P321E090).
- Angles other than 90° upon request.
- Structures with 1, 2, 3 or 4 sides.
- Suspended with eyebolts.
- Vertical connecting crossbars.

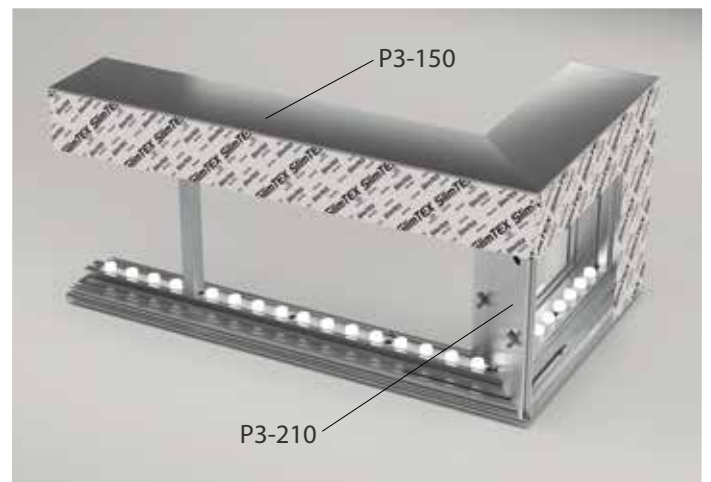
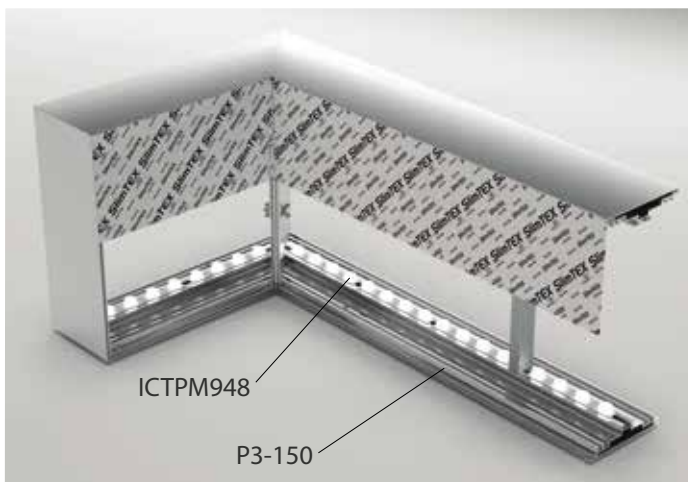

# SLIM.TEX 3D

## SOFT TEXTILE PROFILES FOR STANDS

### SLIMTEX 3D STRUCTURE COMPONENTS

Code	Description	Sales unit
P3-150N3	SLIMTEX S150, double sided frame 150 mm / mill aluminium	bar 3.03 m
P3-150A3	SLIMTEX S150, double sided frame 150 mm / silver anodised	bar 3.03 m
P3-150L3	SLIMTEX S150, double sided frame 150 mm / matte white	bar 3.03 m
P3-150K3	SLIMTEX S150, double sided frame 150 mm / matte black	bar 3.03 m
P3-210N3	SLIMTEX S210, 210 mm vertical corner profile / mill aluminium	bar 3.03 m
P321E090	Corner joint bracket S150-S210 (4 per corner)	unit
P3-20005	Double corner bracket with 4 screws	unit
P3X-23N3	Slimtex XPO, crossbar profile, 20x30x1.5 mm, mill	bar 3.03 m
P3X-00MT	Slimtex XPO, crossbar fixing clamp	unit
ZFAPROL4	Extension piece 110 mm with 4 screws for S40/S75/S120	unit
PTOT500G	Base plate 500 x 110 x 5 mm grey lacquered steel, with fasteners	unit
PT98500P	Reinforcement L 98 mm for PTOT500G, grey lacquered RAL7004	unit
PT72065P	Intermediate base supplement PTOT500G, grey RAL7004	unit
P3-CANSU	Eyebolt kit for M10 suspension + M10x45 screw + washers	unit
P3-SIL10	Slimtex, silicone tension tape, 10 m	roll 10 m
P3-SIL50	Slimtex, silicone tension tape, 50 m	roll 50 m
P3-ADH10	Slimtex, TEXtape adhesive tension tape, 10 m	roll 10 m
P3-ADH50	Slimtex, TEXtape adhesive tension tape, 50 m	roll 50 m

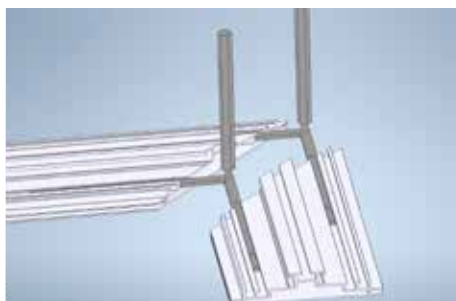

### Possibility of building structures with other angles than 90°

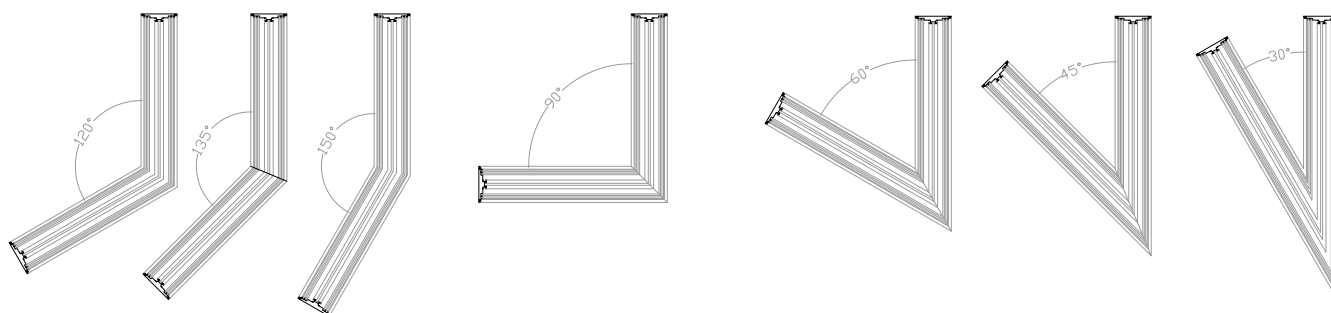

# SLIM.TEX

## SOFT TEXTILE PROFILES

*Slimtex transforms the way frames are created for commercial spaces, offices, events and trade shows. Its silicone edge system, sewn or bonded to the graphic, allows visuals to be changed in seconds with total ease. The Slimtex range includes single and double-sided frames, illuminated or not, in multiple depths. New profiles unlock endless design possibilities—from stands and cubes to arches, complex structures and seamless combinations of rigid panels and textiles.*

### NEW Slimtex QBO



PROFILE DIMENSIONS  
50 x 50 mm

#### S50 CUBE PROFILE (P3-050N3)

Profile for manufacturing textile cubes. Assembly with 24 P3-050EQ brackets.

- Easy to assemble and disassemble with an Allen key.
- Custom kit delivery.
- The cube can be floor-standing or suspended, and can include illumination (Bulbs code BCE27100).



Code	Description	Sales unit
P3-050N3	SlimTEX S50, Cube Profile 50x50mm / mill aluminium	bar 3.03 m
P3-050EQ	SlimTEX, galvanised cube profile bracket with screws	unit
P3-050TR	QBO profile crossbar bracket, galvanised	unit
P7-00C33	Aluminium tube 30x30x2mm, mill aluminium	bar 3.30 m
P3-050UN	QBO profile longitudinal joint plate	unit
P3-050K1	Cube-to-Cube joint spacer kit	kit 4 pcs.
P3-050K2	One-side plate mounting kit	kit 8 pcs.
P3-CANSU	Eyebolt kit for M10 suspension + M10x45 screw + washers	unit



PROFILE DIMENSIONS  
45 x 18 mm

#### LIGHTBOX FRAME S45 (P3-045N3)

Profile for LED-illuminated lightbox. Assembly with 4 or 8 P3-20005 brackets.

Backlit LED .  
Depth: 45 mm.

#### RECOMMENDED LED

#### BACKLIT

X6-20, X6-30

Rigid back strip (10-12 cm between lines)

Code	Description	Sales unit
P3-045N3	SLIMTEX S45, single-sided frame 45 mm / mill aluminium	bar 3.03 m
P3-045A3	SLIMTEX S45, single-sided frame 45 mm / silver anodised	bar 3.03 m
P3-20005	Double corner bracket with 4 screws for S40 / S45 / S75 / S120	unit
ZFAPROL4	Extension piece 110 mm with 4 screws for S40/S45/S75/S120	unit
PTOT380G	Base plate 380 x 55 x 4 mm grey lacquered steel, with fasteners	unit

# SLIM.TEX

## SOFT TEXTILE PROFILES



PROFILE DIMENSIONS  
75 x 20 mm

### LIGHTBOX FRAME S75 (P3-075N3)

Profile for LED-illuminated lightbox. Assembly with 4x P9114611 corner brackets or with 8x P3-20005 brackets. Edgelit or backlit LED.  
Depth: 75 mm.

RECOMMENDED LED	
BACKLIT	EDGELIT
E3-10, E3-20, S5-20	E3 PR Module
X6-20, X6-30	Strip ICTPR050
Backlit strip	Direct PR

Code	Description	Sales unit
P3-075N3	SLIMTEX S75, single-sided frame 75 mm / mill aluminium	bar 3.03 m
P3-075A3	SLIMTEX S75, single-sided frame 75 mm / silver anodised	bar 3.03 m
P3-075L3	SLIMTEX S75, single-sided frame 75 mm / matte white lacquered	bar 3.03 m
P3-075K3	SLIMTEX S75, single-sided frame 75 mm / matte black lacquered	bar 3.03 m
P3-20005	Double corner bracket with 4 screws for S40 / S75 / S120	unit
P9119461	Mounting corner bracket for riveting S75 / S120	unit
P3-EQ000	Crossbar reinforcement bracket (S75)	unit
ZFA125N6	Crossbar profile 25 x 12 mm, mill aluminium	bar 6 m
PTOT380G	Base plate 380 x 55 x 4 mm grey lacquered steel, with fasteners	unit
PTOT500G	Base plate 500 x 110 x 5 mm grey lacquered steel, with fasteners	unit
PT72500P	Reinforcement L 72 mm / PTOT500G, grey lacquered	unit
PT72065P	Supplement for intermediate plate, grey lacquered RAL7004	unit
ZFAPROL4	Extension piece 110 mm with 4 screws for S40/S75/S120	unit

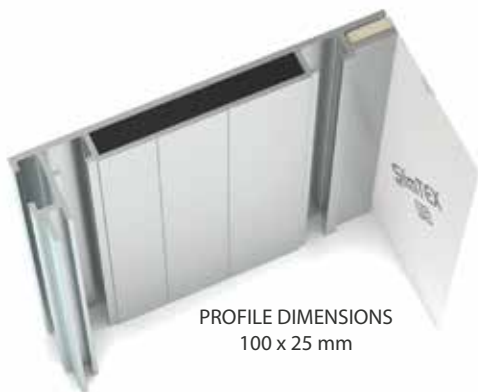

PROFILE DIMENSIONS  
100 x 25 mm

### LIGHTBOX FRAME S100 (P3-100N3)

Profile for LED-illuminated lightbox. Assembly with 8x P3-20005 brackets. Optionally with 4x additional flat GMS24240 brackets in the back groove. Edgelit or backlit LED.  
Depth: 100 mm.

RECOMMENDED LED	
BACKLIT	EDGELIT
E3-10, E3-20, S5-20	E3 PR Module
X6-20, X6-30	Strip ICTPR050
Backlit strip	Direct PR

Code	Description	Sales unit
P3-100N3	SLIMTEX S100, single-sided frame 100 mm / mill aluminium	bar 3.03 m
P3-100A3	SLIMTEX S100, single-sided frame 100 mm / silver anodised	bar 3.03 m
P3-100L3	SLIMTEX S100, single-sided frame 100 mm / matte white	bar 3.03 m
P3-100K3	SLIMTEX S100, single-sided frame 100 mm / matte black	bar 3.03 m
P3-20005	Double corner bracket with 4 screws for S40 / S75 / S100 / S120	unit
GMS24240	Double bracket with screws for S14 / S20 / S100	unit *
P3-EQ000	Crossbar reinforcement bracket (S75/S100)	unit
ZFA125N6	Crossbar profile 25 x 12 mm, mill aluminium	bar 6 m
PTOT500G	Base plate 500 x 110 x 5 mm grey lacquered steel, with fasteners	unit
PT98500P	Reinforcement L 98 mm for PTOT500G, grey lacquered RAL7004	unit
PT72065P	Supplement for intermediate plate, grey lacquered RAL7004	unit
ZFAPROL4	Extension piece 110 mm with 4 screws for S40/S75/S120	unit

\* Sold in boxes of 4 pcs. Surcharge for individual units.

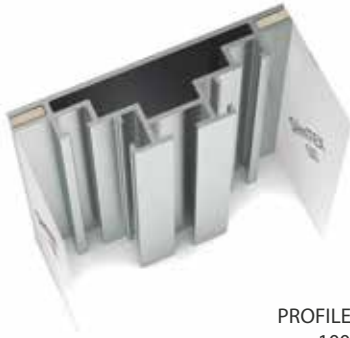

PROFILE DIMENSIONS  
100 x 31 mm

### DOUBLE-SIDED FRAME S102 (P3-102N3)

Profile for double-sided lightbox or totem illuminated with edgelit LED.

Assembly with 8x P3-20005 brackets.

Depth: 100 mm.

For totem base use PTOT500G and the reinforcements stabilisers if needed.

#### RECOMMENDED LED

#### EDGELIT

Strip ICTPM948 / ICTPB500 / ICTPR050

PR MAX Module

Code	Description	Sales unit
P3-102N3	SLIMTEX S102, double sided frame 100 mm / mill aluminium	bar 3.03 m
P3-102A3	SLIMTEX S102, double-sided frame 100 mm / silver anodised	bar 3.03 m
P3-102L3	SLIMTEX S102, double-sided frame 100 mm / matte white	bar 3.03 m
P3-102K3	SLIMTEX S102, double-sided frame 100 mm / matte black	bar 3.03 m
P3-20005	Double corner bracket with 4 screws	unit
P3X-23N3	Slimtex XPO, crossbar profile, 20x30x1.5 mm, mill aluminium	bar 3.03 m
P3X-00MT	Slimtex XPO, crossbar fixing clamp	unit
ZFAPROL4	Extension piece 110 mm with 4 screws for S40/S75/S120	unit
PTOT500G	Base plate 500 x 110 x 5 mm grey lacquered steel, with fasteners	unit
PT98500P	Reinforcement L 98 mm for PTOT500G, grey lacquered RAL7004	unit
PT72065P	Supplement for intermediate plate, grey lacquered RAL7004	unit
P7-EQRAD	Flat bracket for horizontal crossbar assembly	unit

**CORNER BRKT**  
P3-20005



**EXTENSION**  
ZFAPROL4



**CLAMP**  
P3X-00MT



**CROSSBAR**  
P3X-23N3



**SILICONE TAPE**  
P3-SILxx

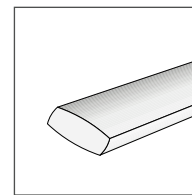

**PVC TAPE ADHESIVE**  
P3-ADH50

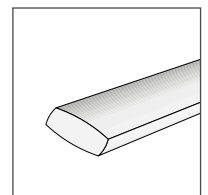

**BASE PLATE**  
PTOT500G



**REINFORCEMENT**  
PT98500P



**BASE SUPPLEMENT**  
PT72065P



# SLIM.TEX

## SOFT TEXTILE PROFILES

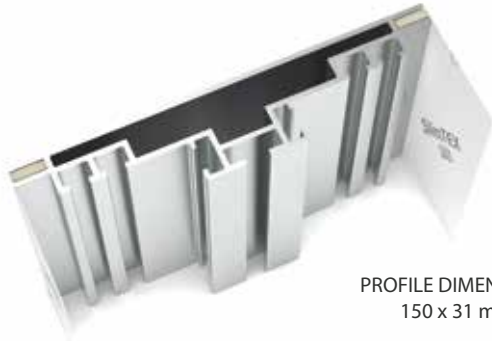

PROFILE DIMENSIONS  
150 x 31 mm

### DOUBLE-SIDED FRAME S150 (P3-150N3)

Profile for double-sided lightbox or totem illuminated with edgelit LED.

Assembly with 8/16x P3-20005 brackets.

Depth: 150 mm.

For totem base use PTOT500G and the reinforcements stabilisers if needed.

#### RECOMMENDED LED

#### EDGELIT

Strip ICTPM948 / ICTPB500 / ICTPR050

PR MAX Module

Code	Description	Sales unit
P3-150N3	SLIMTEX S150, double-sided frame 150 mm / mill aluminium	bar 3.03 m
P3-150A3	SLIMTEX S150, double-sided frame 150 mm / silver anodised	bar 3.03 m
P3-150L3	SLIMTEX S150, double-sided frame 150 mm / matte white	bar 3.03 m
P3-150K3	SLIMTEX S150, double-sided frame 150 mm / matte black	bar 3.03 m
P3-20005	Double corner bracket with 4 screws	unit
P3X-23N3	Slimtex XPO, crossbar profile, 20x30x1.5 mm, mill aluminium	bar 3.03 m
P3X-00MT	Slimtex XPO, crossbar fixing clamp	unit
ZFAPROL4	Extension piece 110 mm with 4 screws for S40/S75/S120	unit
PTOT500G	Base plate 500 x 110 x 5 mm grey lacquered steel, with fasteners	unit
PT98500P	Reinforcement L 98 mm for PTOT500G, grey lacquered RAL7004	unit
PT72065P	Intermediate plate supplement PTOT500G, grey lacquered	unit
P7-EQRAD	Flat bracket for horizontal crossbar assembly	unit

**CORNER BRKT**  
P3-20005



**EXTENSION**  
ZFAPROL4



**CLAMP**  
P3X-00MT



**CROSSBAR**  
P3X-23N3



**SILICONE TAPE**  
P3-SILxx

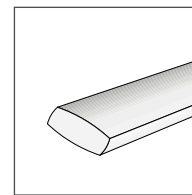

**PVC TAPE ADHESIVE**  
P3-ADH50

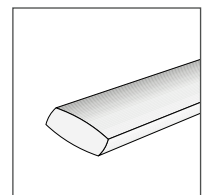

**BASE PLATE**  
PTOT500G



**REINFORCEMENT**  
PT98500P



**BASE SUPPLEMENT**  
PT72065P



# SLIM.TEX

## SOFT TEXTILE PROFILES

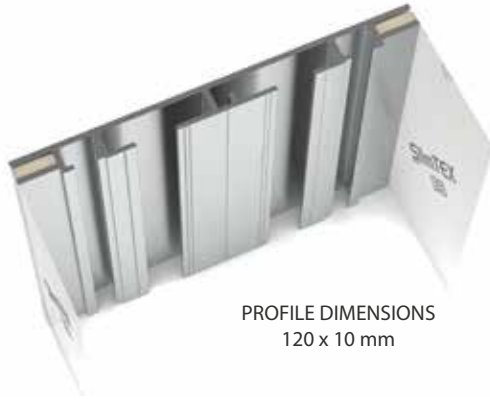

PROFILE DIMENSIONS  
120 x 10 mm

### DOUBLE-SIDED FRAME S120 (P3-120N3)

Profile for LED-illuminated lightbox. Assembly with 8x P9114611 corner brackets or with 8x P3-20005 brackets. Edgelit LED.

Depth: 120 mm.

For totem base use PTOT380G or PTOT500G.

#### RECOMMENDED LED

#### EDGELIT

E3 PR, PR MAX Module

Strip ICTPR050, Direct PR, ICTPM948

Code	Description	Sales unit
P3-120N3	SLIMTEX S120, double-sided frame 120 mm / mill aluminium	bar 3.03 m
P3-120A3	SLIMTEX S120, double-sided frame 120 mm / silver anodised	bar 3.03 m
P3-20005	Double corner bracket with 4 screws for S40 / S75 / S120	unit
P9119461	Mounting corner bracket for riveting S75 / S120	unit
P3-20004	SLIMTEX, bracket for S120 profile crossbar	unit
ZFA125N6	Crossbar profile 25 x 12 mm, mill aluminium	bar 6 m
PTOT500G	Base plate 500 x 110 x 5 mm grey lacquered steel, with fasteners	unit
PT98500P	Reinforcement L 98 mm for PTOT500G, grey lacquered RAL7004	unit
PT72065P	Intermediate plate supplement PTOT500G, grey lacquered	unit
ZFAPROL4	Extension piece 110 mm with 4 screws for S40/S75/S120	unit

#### BRACKET WITH SCREW GMS24240



#### CORNER BRKT WITH SCREW P3-20005



#### EXTENSION ZFAPROL4



#### CORNER BRKT RIVETABLE P9119461



#### CROSSBAR ZFA125N6



#### SILICONE TAPE P3-SILxx

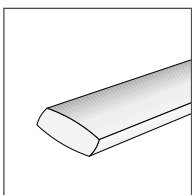

#### PVC TAPE ADHESIVE P3-ADH50

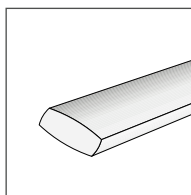

#### BASE PLATE PTOT380G



#### BASE PLATE PTOT500G



### RECESSED FRAME S08 (P3-008N3)

Profile for recess-mounted frame, wall-screwable.

PROFILE DIMENSIONS  
30 x 8 mm



Code	Description	Sales unit
P3-008N3	SLIMTEX S08, 8 mm recessed frame / mill aluminium	bar 3.03 m

### WALL FRAME S14 (P3-014N3)

Profile for frame, wall-screwable. Assembly with 4x GMS24240 corner brackets.  
Depth: 14 mm.

PROFILE DIMENSIONS  
14 x 20 mm



Code	Description	Sales unit
P3-014N3	SLIMTEX S14, 14 mm wall frame / mill aluminium	bar 3.03 m
P3-014A3	SLIMTEX S14, 14 mm wall frame / silver anodised	bar 3.03 m
GMS24240	Double corner bracket with screws for S14 and S20	unit *
GMS24275	S14, S20 extension plate set	unit

\* Sold in boxes of 4 pcs. Surcharge for individual units.

### SILICONE TAPE / ADHESIVE PVC

TEXTape, adhesive PVC tape for textile.  
Transparent silicone tape, ideal for sewing to textile.

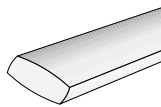

Code	Description	Sales unit
P3-SIL10	SLIMTEX, silicone tension tape, 10 m	roll 10 m
P3-SIL50	SLIMTEX, silicone tension tape, 50 m	roll 50 m
P3-ADH10	SLIMTEX, TEXTape adhesive tension tape, 10 m	roll 10 m
P3-ADH50	SLIMTEX, TEXTape adhesive tension tape, 50 m	roll 50 m



PROFILE DIMENSIONS  
20 x 30 mm

### OPTICAL LED FRAME S20 (P3-020N3)

Profile for illumination using 4-6 mm thick optical acrylic and LEDstrip up to 6 mm wide.

Assembly with 4x GMS24240 brackets.

Depth: 20 mm.

RECOMMENDED LED

EDGELIT

Flexible strip ICFLOPW4, W6

Code	Description	Sales unit
P3-020N3	SLIMTEX S20, optical LED frame 20 mm / bruto	bar 3.03 m
P3-020A3	SLIMTEX S20, optical LED frame 20 mm / silver anodised	bar 3.03 m
GMS24240	Double bracket with screws for S14 and S20	unit *
GMS24275	S14, S20 extension plate set	unit



PROFILE DIMENSIONS  
38 x 20 mm

### DOUBLE-SIDED FRAME S40 (P3-040N3)

Profile for double-sided frame, suspended or freestanding. Illumination with 5-8 mm optical acrylic and LED strip up to 6 mm wide.

Option for non-illuminated frame using GCC633N0 reinforcement crossbars.

Assembly with screw bracket P3-20005.

Depth: 40 mm.

RECOMMENDED LED

EDGELIT

Flexible strip ICFLOPW4, W6

Code	Description	Sales unit
P3-040N3	SLIMTEX S40, double-sided frame 38 mm / bruto	bar 3.03 m
P3-040A3	SLIMTEX S40, double-sided frame 38 mm / silver anodised	bar 3.03 m
P3-20005	Double corner bracket with 4 screws for S40 / S75 / S120	unit
GCC633N0	Crossbar profile, mill aluminium / S40	metre
P3-30040	Base plate for S40 double-sided frame	unit
ZFATRCM5	Sliding M5 nut for S40 rail fixing	unit
ZFAPROL4	Extension piece 110 mm with 4 screws for S40/S75/S120	unit

# SLIM.TEX

## SOFT TEXTILE PROFILES

**BRACKET  
WITH SCREW**  
GMS24240



**CORNER BRKT  
WITH SCREW**  
P3-20005



**EXTENSION**  
ZFAPROL4



**EYEBOLT**  
WIND005C



**CROSSBAR**  
GCC633N0

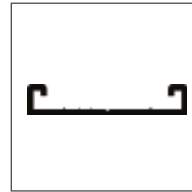

**NUT**  
ZFATRCM5



**SILICONE TAPE**  
P3-SILxx

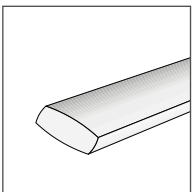

**PVC TAPE  
ADHESIVE**  
P3-ADH50

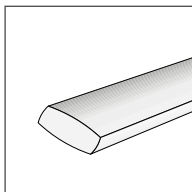

**BASE PLATE**  
P3-30040



**BASE PLATE**  
PTOT380G



Q|tex is a simple tension system that allows creating frames for photos or artistic canvases for private, commercial and office use.

With concealed subframe or aluminium frame. No tools required for assembly. Additionally, the image can be changed effortlessly as many times as needed.

Recommended printing substrates: any canvas, textile or fabric between 125 and 270 g/m<sup>2</sup>.

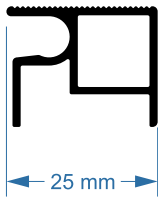

### Q1 SUBFRAME PROFILE (NQ0001\_)

Aluminium profile for mounting canvas on frame.

By wrapping the subframe with printed fabric, an artistic piece is achieved very decorative and three-dimensional.

In 3m bars.  
20 x 25 mm.

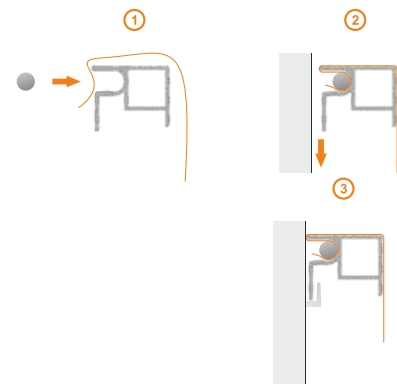

Code	Description	Sales unit
NQ0001N0	Qtex Q1, concealed subframe profile, mill aluminium	l.m.
P7-000EQ	ECOFLEX, mounting bracket / grey ABS	unit
NQ000565	Qtex, silver PVC cord Ø6.5mm, 50m roll	roll

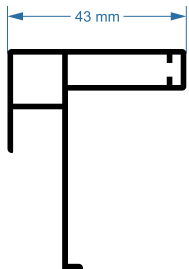

### Q3 EXTERIOR SURROUND PROFILE (NQ0003\_)

Visible exterior aluminium surround profile.

Enhances the visual impact of the Q1 frame by adding the Q3 frame to the perimeter.

Q|tex Q3 is NOT a tension profile. It is a finishing profile to be used together with Q1.  
In 3m bars. 43 x 53 mm.

Code	Description	Sales unit
NQ0003N0	Qtex Q3, perimeter frame profile mill aluminium	l.m.
NQ0003AP	Qtex Q3, perimeter frame profile silver anodised	l.m.
P7-000EQ	ECOFLEX, mounting bracket / grey ABS	unit
NQ00EQAL	Qtex, Q3 frame alignment bracket	unit

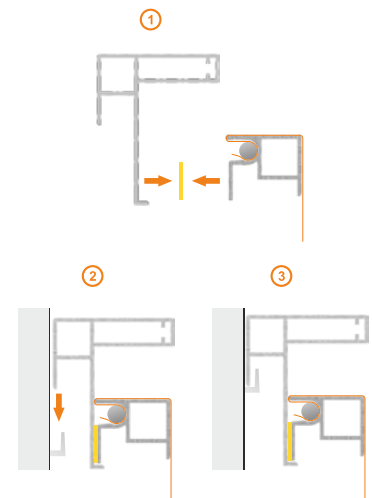

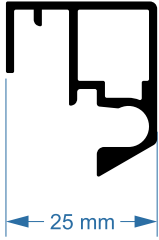

### Q2 VISIBLE ALUMINIUM FRAME PROFILE (NQ0002\_)

Visible aluminium frame profile.

Together with manual tool-free assembly offers flexibility with multiple decorative options.

In 3m bars.

25 x 29 mm.

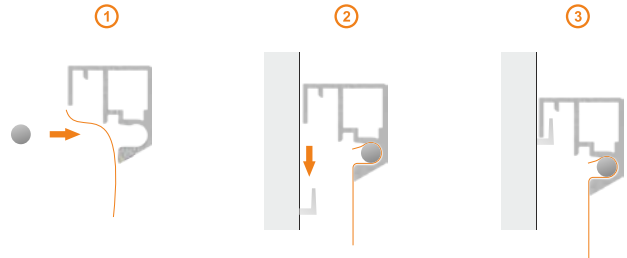

Code	Description	Sales unit
NQ0002N0	Qtex Q2, visible frame profile mill aluminium	l.m.
NQ0002AP	Qtex Q2, visible frame profile silver anodised	l.m.
P7-000EQ	ECOFLEX, mounting bracket / grey ABS	unit
NQ000565	Qtex, silver PVC cord Ø6.5mm, 50m roll	roll



P7-000EQ



NQ000565



NQ00EQAL

3m bars. Price per linear metre. Standard kits available in various sizes.



VIDEO





# PVC Flex face Profiles (Tension clip)

# LUMI-SIGN

## FLEXIBLE FACE SIGNS

Lumi-Sign is a versatile system designed for the production of lightboxes with flexible faces, illuminated or non-illuminated. It offers a comprehensive range of profiles to suit every application, with compatibility for both plastic and aluminium clips—ensuring maximum flexibility in assembly.

Both frames and the Retro profile can be curved, opening the door to creative, shaped and fully customized signage solutions.

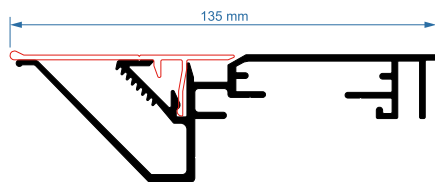

### LUMI-SIGN 135 mm (SC8135N6)

Flexible face single side lightbox, body frame. Depth: 135 mm. Recommended for lightboxes up to 2 m high. Flat or angle cover.

Code	Description	Sales unit
SC8135N6	Lumi-Sign, profile 135 mm mill aluminium	bar 6 m
SC8135L6	Lumi-Sign, profile 135 mm white lacquered aluminium	bar 6 m
SC710900	Lumi-Sign, reinforcement bracket profile SC8135	unit
SC745000	Lumi-Sign, mounting corner bracket para SC8135	unit
SC745100	Lumi-Sign, joint for SC8135	unit
SC745200	Lumi-Sign, 90° corner joint for SC8135	unit

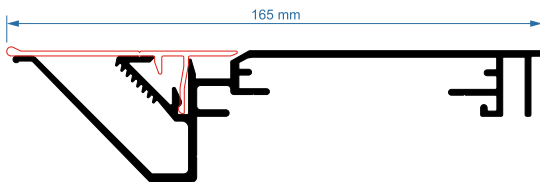

### LUMI-SIGN 165 mm (SC8165N6)

Flexible face single side lightbox, body frame. Depth: 165 mm. Recommended for lightboxes up to 3.5 m high. Flat or angle cover.

Code	Description	Sales unit
SC8165N6	Lumi-Sign, profile 165 mm mill aluminium	bar 6 m
SC8165L6	Lumi-Sign, profile 165 mm white lacquered aluminium	bar 6 m
SC710700	Lumi-Sign, reinforcement bracket profile SC8165	unit
SC746000	Lumi-Sign, mounting corner bracket para SC8165	unit
SC746100	Lumi-Sign, joint for SC8165	unit
SC746200	Lumi-Sign, 90° corner joint for SC8165	unit

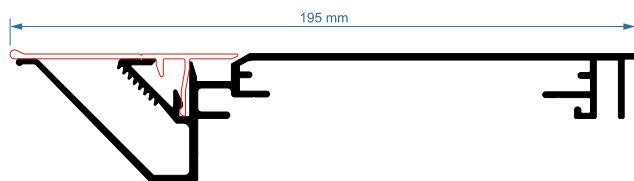

### LUMI-SIGN 195 mm (SC8195N6)

Flexible face single side lightbox, body frame. Depth: 195 mm. Recommended for lightboxes up to 5 m high. Flat or angle cover.

Code	Description	Sales unit
SC8195N6	Lumi-Sign, profile 195 mm mill aluminium	bar 6 m
SC8195L6	Lumi-Sign, profile 195 mm white lacquered aluminium	bar 6 m
SC710500	Lumi-Sign, reinforcement bracket profile SC8195	unit
SC740000	Lumi-Sign, mounting corner bracket para SC8195	unit
SC740100	Lumi-Sign, joint for SC8195	unit
SC740200	Lumi-Sign, 90° corner joint piece for SC8195	unit

# LUMI-SIGN

## FLEXIBLE FACE SIGNS

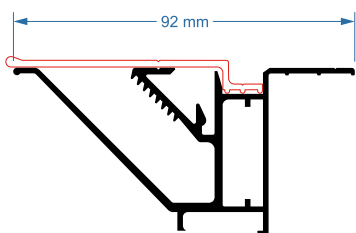

### LUMI-SIGN RETROFIT TENSION PROFILE (SC8105N6)

Flexible face tension profile, on existing structure.  
Compatible with all Lumi-Sign SC8xxx covers.

Code	Description	Sales unit
SC8105N6	LumiSign, retrofit tension profile, mill aluminium	bar 6 m
SC8105L6	LumiSign, retrofit tension profile, white lacquered aluminium	bar 6 m
SC521000	LumiSign, corner key for retro profile	unit
ZFA125N6	Crossbar profile 25 x 12 mm, mill aluminium	bar 6 m
SC521100	LumiSign, flat joint for retro profile	unit

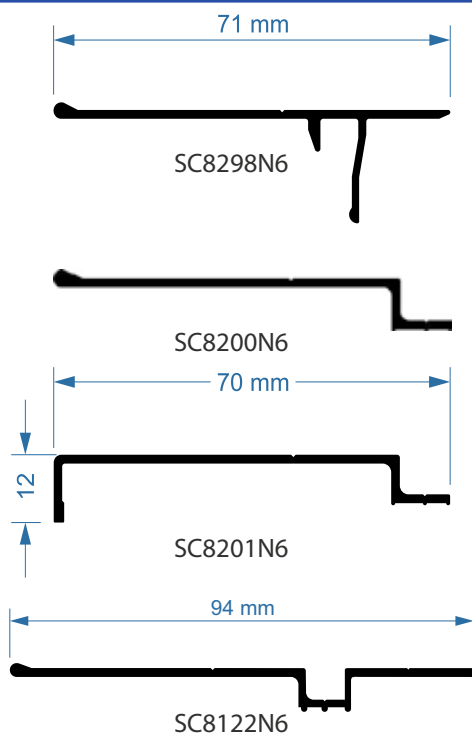

### CLIP ON FLAT COVER (SC8298N6)

Cover compatible with all SC8xxx profiles.  
Clip on assembly. Can also be screwed.

### SCREW FIX FLAT COVER

Cover compatible with all profiles SC8xxx.  
Screw fix.

### SCREW FIX ANGLE COVER

Cover compatible with all profiles SC8xxx.  
Screw fix.

### SCREW FIX FLAT COVER FOR RETRO PROFILE (SC8122N6)

Screw fix cover that fully covers the SC8105N6 profile.  
Not compatible with other Lumi-Sign profiles.

Code	Description	Sales unit
SC8298N6	Clip on flat cover, mill aluminium	bar 6 m
SC8298L6	Clip on flat cover, white lacquered aluminium	bar 6 m
SC8200N6	Screw fix flat cover, mill aluminium	bar 6 m
SC8200L6	Screw fix flat cover, white lacquered aluminium	bar 6 m
SC8201N6	Screw fix angular cover, mill aluminium	bar 6 m
SC8201L6	Screw fix angular cover, white lacquered aluminium	bar 6 m
SC8122N6	LumiSign, flat cover for retrofit, mill alum.	bar 6 m
SC8122L6	LumiSign, flat cover for retrofit, white lac. alum.	bar 6 m

# LUMI-SIGN

## FLEXIBLE FACE SIGNS

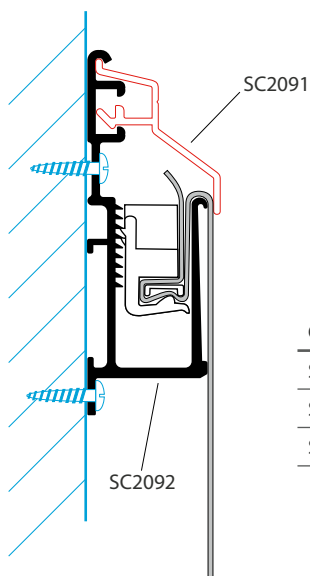

### FACADE FRAME (SC2092N6 + SC2091N6)

Large format flexible face frame.  
Non-illuminated frame for PVC flex face.  
Allows large-format signs.  
SC2091 cover.

Code	Description	Sales unit
SC2092N6	Large format flexible face frame, body frame	bar 6 m
SC2091N6	Clip on cover - Mill aluminium	bar 6 m
SC2091L6	Clip on cover - White lacquered aluminium	bar 6 m

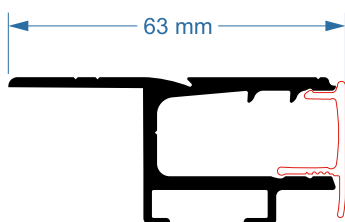

### LUMIGRIP TENSION PROFILE (P61007N6 + P61010N6)

Flexible face tension profile, on existing structure.  
Front insertion profile.  
*Only compatible with aluminium tension clip P8909500.*

Code	Description	Sales unit
P61007N6	L-GRIP, front insertion profile / mill aluminium	bar 6 m

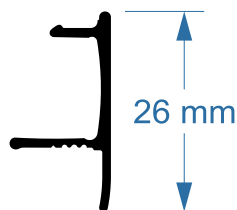

### LUMIGRIP FRAME COVER (P61010N6)

Cover compatible with LumiGrip profile. Clip on assembly, no screws.

Code	Description	Sales unit
P61010N6	L-GRIP, 24mm clip on cover / mill aluminium	bar 6 m

# LUMI-SIGN

## FLEXIBLE FACE SIGNS

### Common elements

SC8500N6, back support



SC799900

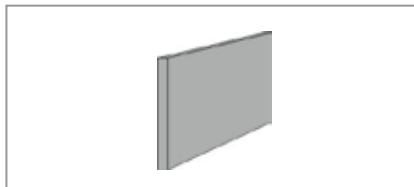

ZFA125N6



SC536000, plastic tension clip



P8909500, alum. tension clip



P919-3DT, alu clip pliers



Code	Description	Sales unit
SC536000	Tension clip - plastic	unit
P8909500	Tension clip - aluminium	unit
SC8500N6	Back support 55x20 mm / 6m	bar 6 m
SC950100	Flat joint for SC8500	unit
SC799900	Econoflex lock	unit
ZFA125N6	Crossbar profile 25 x 12 mm, mill aluminium	bar 6 m
SC513500	Tensioning tool	unit
SC513700	Tensioning tool for SC2092	unit
SC513800	Tensioning tool for SC2092 narrow access	unit
P919-3DT	Alu clip assembly pliers	unit
SC7500N3	Corner tension profile, mill aluminium	bar 2.5 m
SC7700N3	Outer corner cover profile, mill aluminium	bar 2.5 m
SC7600N3	Inner corner cover profile, mill aluminium	bar 2.5 m
SC7550N3	Flat cover profile, mill aluminium	bar 3 m

### Tensioning tools

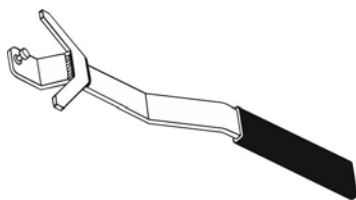

SC513500  
All systems except facade frame.

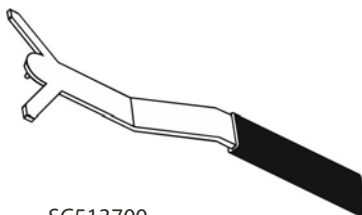

SC513700  
For tensioning the facade frame.

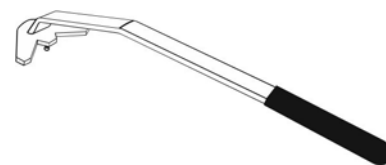

SC513800  
For tensioning the facade frame in narrow access locations.

# LUMI-SIGN

## FLEXIBLE FACE SIGNS

### A solution for every application

MODEL	CODE	DEPTH	H max	L max	1/2 SIDES	ILLUMINATED	NON-ILLUMINATED	RETROFIT	ALUMINIUM CLIP	PLASTIC CLIP	REMARKS
Lightbox 135	SC8135	135 mm	2m	∞	1	√	-	-	√	√	
Lightbox 165	SC8165	165 mm	4m	∞	1	√	-	-	√	√	
Lightbox 195	SC8195	195 mm	8m	∞	1	√	-	-	√	√	Large-format illuminated lightbox
Retro profile	SC8105	-	5m	∞	1/2	-	-	√	√	√	Assembly on existing frame
Facade Frame	SC2092	30 mm	5m	∞	1	√	√	-	√	√	
LGrip Retro	P61007	-	5m	∞	1/2	-	-	√	√	-	For front insertion sign

### Modular signs

- Manufacturing large-format signs is possible with the Lumi-Sign profile range.
- Module design between 3 and 4 metres maximum length is recommended, to simplify transport and allow installation with just two people. Consider the transport method to define module size.
- A sign can be split into modules both in length and height.

Sign height	Module height	Module length
> 1 m	Total height	3 - 4 m
1 to 2 m	Total height	3 - 4 m
2 to 3 m	Total height	2 m
3 to 4 m	Total height	2 m
4 to 5 m (1)	Total height	1,5 m
4 to 5 m (2)	Total height / 2	3 m

From 4 metres height, the height can be made in one piece or split into two modules.

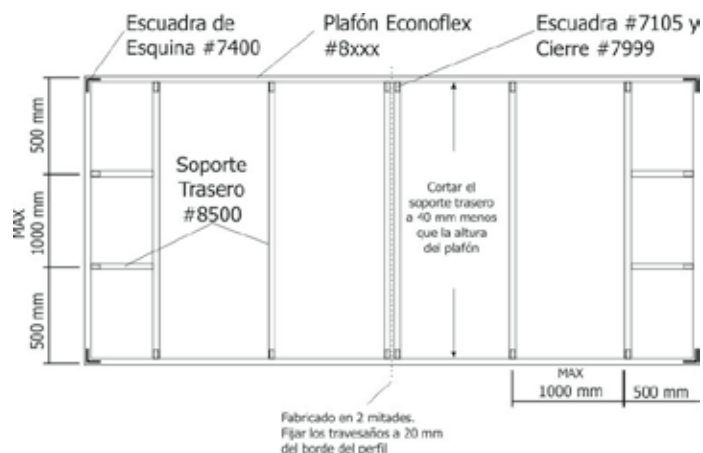

# LUMI-SIGN

## FLEXIBLE FACE SIGNS

### Shaped signs

- The lightbox and Retro profiles can be curved for large-format PVC flex face signs with complex shapes.
- Through radial cuts in the inner side, the profile can be adapted to the required shape. The profile is then fixed by welding.
- The distance between cuts is determined by the defined bending radius.

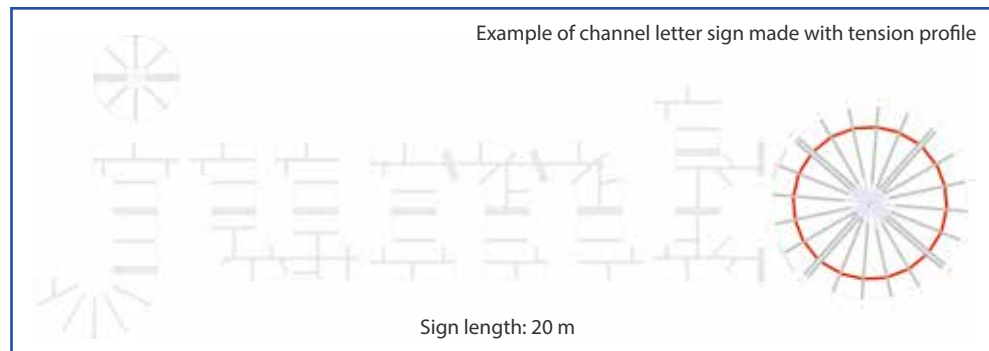

### Canvas preparation

#### Flexible front cutting

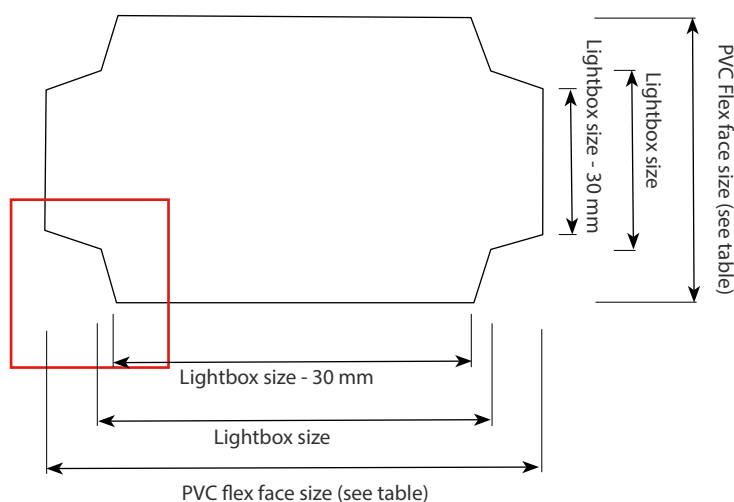

#### Flexible front face size per profile

Profile	PVC size with plastic clip	PVC size with aluminium clip
Lightbox 195 mm Lightbox 165 mm Lightbox 135 mm Hinge lightbox Retrofit profile	Lightbox size + 180 mm	Lightbox size + 110 mm
Facade frame	Lightbox size + 80 mm	Lightbox size (+ 0 mm)
LumiGrip	Not compatible	Lightbox size + 45 mm

# ECOFLEX

## PVC FLEX FACE - TENSION STRIP

Ecoflex is a high-performance tension system for flexible graphics, offering one of the most versatile solutions on the market. Achieve perfectly tensioned visuals quickly and effortlessly—ideal for temporary signage and architectural applications. From façade coverings and large-format signage to exhibition stands, POS displays, ceiling cladding and vehicle graphics, Ecoflex adapts to any project. Recommended for fabrics up to 500 g/m<sup>2</sup>.



### EC PROFILE, 20 x 9 mm (P7-00CN3)

Used in small and medium format frames, for vehicle signage and adaptation to any existing structure. Hand-bendable. 1 groove.

Code	Description	Sales unit
P7-00CN3	ECOFLEX, "EC" profile, 20x9mm / mill aluminium	bar 3.03 m



### EKTA PROFILE, 27 x 9 mm (P7-KTAN3)

Used in small and medium format frames. 1 groove.

Code	Description	Sales unit
P7-KTAN3	ECOFLEX, "EKTA" profile / mill aluminium	bar 3.03 m



### EKTA PLUS PROFILE, 34 x 10 mm (P7-KA+N3)

Thanks to its strength, it allows medium and large non-illuminated façade frames. 1 groove.

Code	Description	Sales unit
P7-KA+N3	ECOFLEX, "EKTA PLUS" profile / mill aluminium	bar 3.03 m

# ECOFLEX

## PVC FLEX FACE - TENSION STRIP

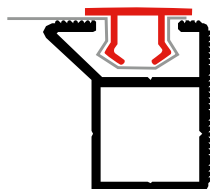

### EKTN PROFILE, 22 x 20 mm (P7-KTNN3)

Designed for frames with 21 mm depth to small and medium format frames.  
1 groove.

Code	Description	Sales unit
P7-KTNN3	ECOFLEX, "EKTN" profile, 21mm / mill aluminium	bar 3.03 m
P7-000EQ	ECOFLEX, mounting bracket / grey ABS	unit
P7-0TUN3	ECOFLEX, tube Ø12mm / mill aluminium	bar 3.03 m
P7-0TU15	ECOFLEX, tube Ø12mm. Bag 10 pcs 15 cm / mill aluminium	bag 10 pcs.

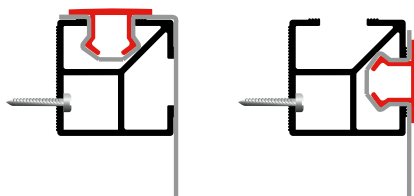

### EKT2 PROFILE, 25 x 25 mm (P7-KT2N3)

Designed for frames with 25 mm depth to small and medium format frames.  
2 grooves.

Code	Description	Sales unit
P7-KT2N3	ECOFLEX, "EKT2" profile / mill aluminium	bar 3.03 m
P7-000EQ	ECOFLEX, mounting bracket / grey ABS	unit

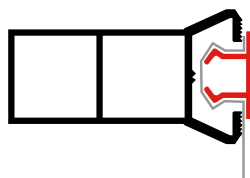

### EKP PROFILE, 34 x 20 mm (P7-0KPN0)

Designed for frames with 34 mm depth to small and medium format frames.  
1 groove.

Code	Description	Sales unit
P7-0KPN0	ECOFLEX, "EKP" profile 35mm / mill aluminium	bar 3.50 m
P7-000EQ	ECOFLEX, mounting bracket / grey ABS	unit
P7-0TUN3	ECOFLEX, tube Ø12mm / mill aluminium	bar 3.03 m
P7-0TU15	ECOFLEX, tube Ø12mm. Bag 10 pcs 15 cm / mill aluminium	bag 10 pcs.

# ECOFLEX

## PVC FLEX FACE - TENSION STRIP

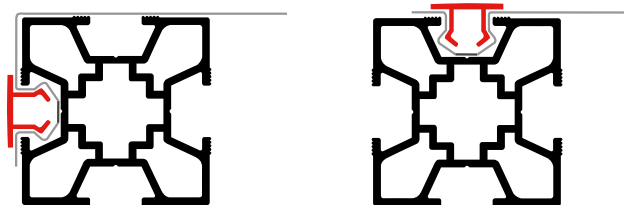

### EKT4 PROFILE, 36 x 36 mm (P7-KT4N3)

Medium & large format frames, constructive structures for stands, 3D volumetric constructions and furniture.

4 grooves.

Code	Description	Sales unit
P7-KT4N3	ECOFLEX, "EKT4" profile, 36x36mm / mill aluminium	bar 3.03 m
P7-000EQ	ECOFLEX, mounting bracket / grey ABS	unit
P7-0TUN3	ECOFLEX, tube Ø12mm / mill aluminium	bar 3.03 m
P7-0TU15	ECOFLEX, tube Ø12mm. Bag 10 pcs 15 cm / mill aluminium	bag 10 pcs.
P7-0EQKT	ECOFLEX, 90° mounting bracket, for profile "EKT+"	unit
P7-0KTCL	ECOFLEX, screw plate for profile "EKT+"	unit

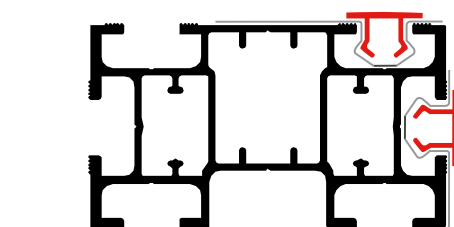

### EKT+ PROFILE, 64 x 36 mm (P7-KT+N3)

Profile for large-format non-illuminated signage, decoration, ephemeral architecture and stands.

6 grooves.

Code	Description	Sales unit
P7-KT+N3	ECOFLEX, "EKT+" profile, 64x36mm / 3.03m / mill aluminium	bar 3.03 m
P7-000EQ	ECOFLEX, mounting bracket / grey ABS	unit
P7-0TUN3	ECOFLEX, tube Ø12mm / mill aluminium	bar 3.03 m
P7-0TU15	ECOFLEX, tube Ø12mm. Bag 10 pcs 15 cm / mill aluminium	bag 10 pcs.
P7-0EQKT	ECOFLEX, 90° mounting bracket, for profile "EKT+"	unit
P7-0KTCL	ECOFLEX, screw plate for profile "EKT+"	unit



P7-JIN3B

P7-JIN3N

P7-JEX3B

### PVC TENSION STRIP

Allows tensioning of PVC flex face from 300 to 500 g/m<sup>2</sup>.

Code	Description	Sales unit
P7-JIN3B	ECOFLEX, PVC tension strip for INDOOR / white	bar 3.03 m
P7-JIN3N	ECOFLEX, PVC tension strip for INDOOR / black	bar 3.03 m
P7-JEX3B	ECOFLEX, PVC tension strip for OUTDOOR / white	bar 3.03 m

# ECOFLEX

## PVC FLEX FACE - TENSION STRIP

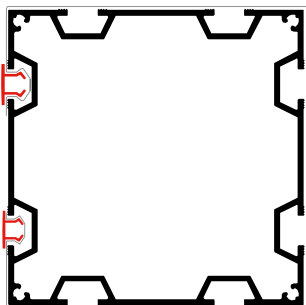

### EP100 PROFILE, 100 x 100 mm (P7-301N0)

Profile for building very large format structures such as facade and stand cladding.  
8 grooves.

Code	Description	Sales unit
P7-301N0	ECOFLEX, profile "EP100" 100x100mm / mill aluminium	bar 4.10 m
P7-30111	ECOFLEX, 90° mounting bracket / "EP100"	unit
P7-30115	ECOFLEX, inner flat bracket "L" / "EP100"	unit
P7-30120	ECOFLEX, support plate 400x140mm / for "EP100"	unit
P7-30121	ECOFLEX, 2-bolt plate 15x80mm / for "EP100"	unit
P7-30125	ECOFLEX, extension plate 95x230mm / "EP100"	unit

## Tools

P7-00011

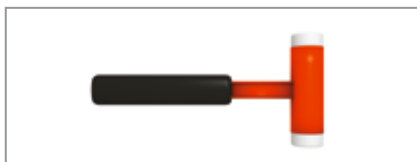

P7-00015



VIDEO

Code	Description	Sales unit
P7-00011	Non-rebound nylon hammer	unit
P7-00015	ECOFLEX, strip cutting pliers	unit

### Fabric trimming

Once the fabric has been correctly tensioned according to the chosen finishing method, trim the fabric along the bead or one of the profile guides.

For tensioning the, always use one non-rebound hammer

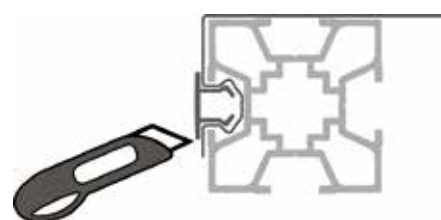
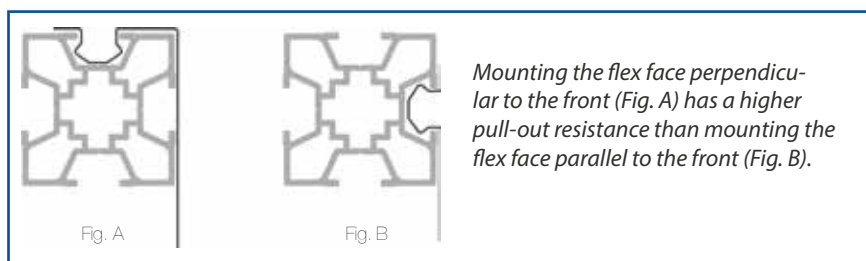

# WIND

## SUSPENDED ADVERTISING

Wind is a simple and highly functional system for hanging advertising at the point of sale.

It is the ideal option for displaying advertising or signage anywhere, hanging from the ceiling, as a banner or wall-mounted, using just two aluminium profiles to achieve ideal tension for any substrate. It can also be used with a rigid panel instead of canvas.

A finished product is available in just a few minutes.



1



2



3



4



### WIND PROFILE AND CAP

Diameter 30 mm.

Profile available in mill and silver anodised aluminium.

Grey PP cap.

Code	Description	Sales unit
WIND00N3	Profile Ø30mm, mill aluminium	bar 3 m
WIND00A3	Profile Ø30mm, silver anodised	bar 3 m
WIND0063	Rod Ø6.3mm, mill aluminium	bar 3 m
WIND0021	Grey polypropylene cap	unit *
WIND00T5	Fixing screw 5x16mm, bag 50 pcs.	bag

\* Sold in boxes of 50 pcs. Surcharge for individual units.



VIDEO

# WIND

## SUSPENDED ADVERTISING



### EYEBOLT + BASE

For ceiling suspension by cable.

Instead of the base, ZFATRCM5 can also be used



Code	Description	Sales unit
WIND005C	Hanging threaded eyebolt	unit
WIND005Z	Threaded base	unit
ZFATRCM5	Sliding M5 nut (base), screw not included	unit



### WALL FIXING BRACKET

Use together with WIND005Z base.

Code	Description	Sales unit
GMC54001	Wall fixing bracket	unit



### INVISIBLE EXTENSION

Code	Description	Sales unit
ZFAPROL4	Extension piece 110 mm with 4 screws	unit





# Profiles for Acrylic face

# ECONOBOX

## PROFILES FOR ACRYLIC FACE

EconoBox is smart profile systems for rigid panels, designed to create single and double-sided lightboxes with maximum efficiency.

EconoBox offers a simple and cost-effective solution.

The system use standard inner structures—easy to source, easy to assemble, and built for reliable performance.

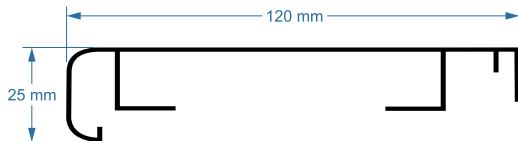

### LIGHTBOX 120 mm (PBB101N6)

Profile for single sided acrylic lightbox. Depth: 120 mm. Available in mill aluminium, white and black lacquered.

Code	Description	Sales unit
PBB101N6	EconoBOX, single sided frame 120mm / mill aluminium	bar 6 m
PBB101L6	EconoBOX, single sided frame 120mm / white lacquered	bar 6 m
PBB101K6	EconoBOX, single sided frame 120mm / black lacquered	bar 6 m

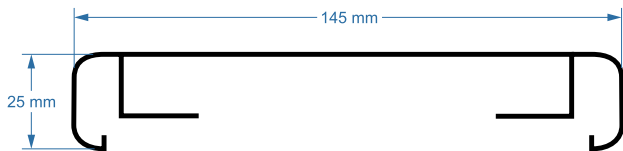

### LIGHTBOX / BANNER 145 mm (PBB102N6)

Profile for single/double sided acrylic lightbox. Depth: 145 mm. Available in mill aluminium, white and black lacquered.

Code	Description	Sales unit
PBB102N6	EconoBOX, double sided frame 145mm / mill aluminium	bar 6 m
PBB102L6	EconoBOX, double sided frame 145mm / white lacquered	bar 6 m
PBB102K6	EconoBOX, double sided frame 145mm / black lacquered	bar 6 m



### MOUNTING CORNER BRACKET

Mounting corner bracket for 90° right-angle corners.

Mounting corner bracket for rounded corners in 145 mm frame depth.

Code	Description	Sales unit
PBB10301	EconoBOX, 83 mm corner bracket for 120 mm profile	unit
PBB10302	EconoBOX, 115 mm corner bracket for 145 mm profile	unit
PBB10411	EconoBOX, rounded corner set 145 mm profile, mill aluminium	unit

# ECONOBOX

## PROFILES FOR ACRYLIC FACE



### LIGHTBOX REINFORCEMENT BRACKET (PBB10101)

Reinforcement bracket for crossbar.  
For 120 and 145 mm lightboxes.

Code	Description	Sales unit
PBB10101	EconoBOX, lightbox reinforcement bracket	unit
PBB10112	EconoBOX, flat extension piece 120 mm profile	unit
PBB10212	EconoBOX, flat extension piece 145 mm profile	unit

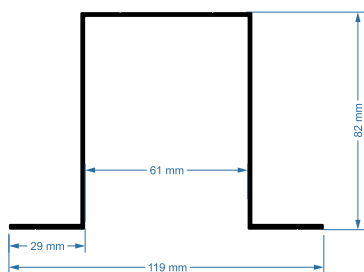

### STAND-OFF BRACKET (PBA212N3)

Stand-off bracket profile for double sided signs, below 1 m<sup>2</sup>.  
Available in mill aluminium, white and black lacquered.

Code	Description	Sales unit
PBA212N3	Stand-off bracket profile, mill aluminium	bar 3 m
PBA212L3	Stand-off bracket profile, white lacquered	bar 3 m
PBA212K3	Stand-off bracket profile, black lacquered	bar 3 m



### REINFORCEMENT CROSSBAR (ZFA125N6)

Allows vertical reinforcement of 120 mm lightboxes.  
Used together with the PBB10101 bracket.  
25 x 12 mm.

Code	Description	Sales unit
ZFA125N6	Crossbar profile 25 x 12 mm, mill aluminium	bar 6 m



### DOUBLE SIDED REINFORCEMENT

To fix also lighting fixtures in the lightbox.  
PBB10115: Crossbar support bracket, 115 mm  
ZFA15LN6: Crossbar profile

Code	Description	Sales unit
PBB10115	EconoBOX, lightbox crossbar support angle, 115mm	unit
ZFA20LN6	Angle profile 20x20x1.5 mm, for crossbar	bar 6 m

# ECONOCLIP

## PROFILES FOR ACRYLIC FACE

*ECONOCLIP is a profile system for construction of single and double sided lightboxes, with rigid face and clip on fixing. ECONOCLIP features a clip on cover system with one frame and interchangeable covers for easy access and maintenance.*

*The cap clips onto the main profile, allowing signs with front acrylic insertion.*

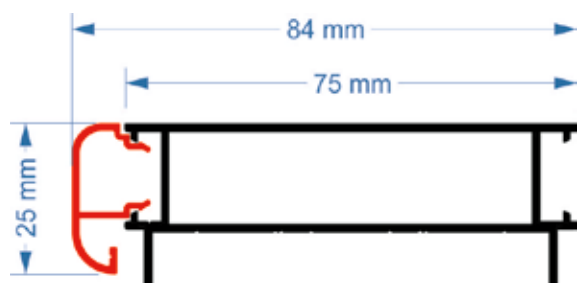

### SINGLE SIDED LIGHTBOX 84 mm (PBB105N6 + PBB106N6)

Single sided acrylic lightbox + cover.

Depth: 84 mm.

Available in mill aluminium, white and black lacquered.

Acrylic: max 4 mm.

Back panel: max 3 mm.

#### RECOMMENDED LED

BACKLIT	EDGELIT
E3-20, S5-20, X6-20	E3 PR Module
Rigid backlit strip	Strip ICTPR050

Code	Description	Sales unit
PBB105N6	EconoCLIP, main body profile 75mm / mill aluminium	bar 6 m
PBB105L6	EconoCLIP, main body profile 75mm / white lacquered	bar 6 m
PBB105K6	EconoCLIP, main body profile 75mm / black lacquered	bar 6 m
PBB106N6	EconoCLIP, clip on cover / mill aluminium	bar 6 m
PBB106L6	EconoCLIP, clip on cover / white lacquered	bar 6 m
PBB106K6	EconoCLIP, clip on cover / black lacquered	bar 6 m

### Accessories

Mounting corner bracket, crossbar reinforcement bracket, crossbar profile and extension piece.

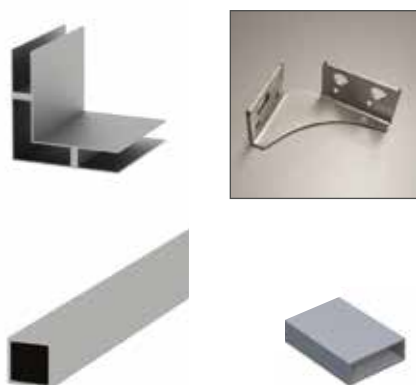

Code	Description	Sales unit
PBB10303	EconoCLIP, mounting corner bracket for 75 mm profile	unit
P3-EQ000	Crossbar reinforcement bracket	unit
ZFA125N6	Crossbar profile 25 x 12 mm, mill aluminium	bar 6 m
PBB10512	EconoCLIP, extension piece for 75 mm profile	unit

# ECONOCLIP

## PROFILES FOR ACRYLIC FACE

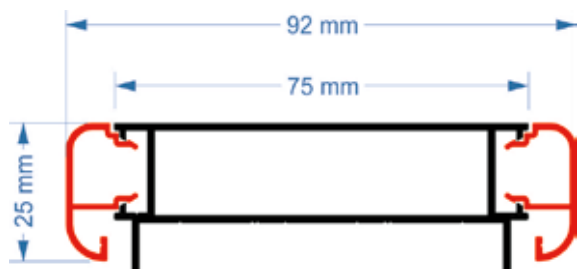

### DOUBLE SIDED LIGHTBOX 92 mm (PBB105N6 + PBB106N6)

Double sided acrylic lightbox + 2 covers.

Depth: 92 mm.

Available in mill aluminium, white and black lacquered.

Acrylic: max

#### RECOMMENDED LED

#### EDGELIT

E3 PR Module

Strip ICTPR050

Code	Description	Sales unit
PBB105N6	EconoCLIP, main body profile 75mm / mill aluminium	bar 6 m
PBB105L6	EconoCLIP, main body profile 75mm / white lacquered	bar 6 m
PBB105K6	EconoCLIP, main body profile 75mm / black lacquered	bar 6 m
PBB106N6	EconoCLIP, clip on cover / mill aluminium (2 sides)	bar 6 m
PBB106L6	EconoCLIP, clip on cover / white lacquered (2 sides)	bar 6 m
PBB106K6	EconoCLIP, clip on cover / black lacquered (2 sides)	bar 6 m

### Accessories

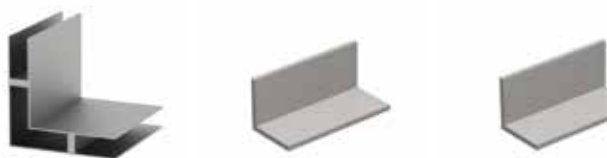

Mounting corner bracket, crossbar support angle and angle profile for crossbar.

Code	Description	Sales unit
PBB10303	EconoCLIP, mounting corner bracket for 75 mm profile	unit
PBB10064	Crossbar support angle	unit
ZFA20LN6	Angle profile 20x20x1.5 mm, for crossbar	bar 6 m

### STAND-OFF BRACKET (PBA212N3)

Stand-off bracket profile for double sided signs, below 1 m<sup>2</sup>.

Available in mill aluminium, white and black lacquered.

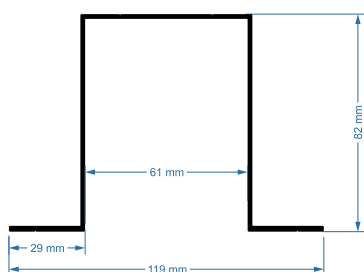

Code	Description	Sales unit
PBA212N3	Stand-off bracket profile, mill aluminium	bar 3 m
PBA212L3	Stand-off bracket profile, white lacquered	bar 3 m
PBA212K3	Stand-off bracket profile, black lacquered	bar 3 m

# FLAT PROFILES

## PROFILES FOR METHACRYLATE

A simple and cost-effective solution for series of acrylic lightboxes.

The system use standard inner structures—easy to source, easy to assemble, and built for reliable performance. Both profiles can be curved and allow building single and double sided lightboxes with acrylic up to 4 mm thick.

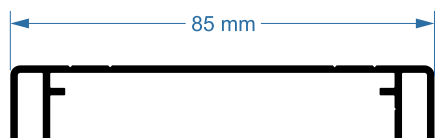

### SINGLE/DOUBLE SIDED LIGHTBOX 85 mm (PBA217N6)

Profile for acrylic lightboxes. Dimensions: 15 x 85 mm.

Code	Description	Sales unit
PBA217N6	Lightbox frame 15x85 mm / mill aluminium	bar 6 m
PBA217L6	Lightbox frame 15x85 mm / white lacquered	bar 6 m
PBA21702	Mounting corner bracket profile 15x85mm (217)	unit
PBA21703	Extension plate for PBA217N6	unit
P3-EQ000	Lightbox crossbar reinforcement bracket (PBA217N0)	unit
ZFA125N6	Crossbar profile 25 x 12 mm, mill aluminium	bar 6 m
ZFA20LN6	Profile "L" 20x20mm, mill alu., banner crossbar for lighting	bar 6 m
PBB10067	Crossbar support angle PBA217, 67 mm	unit



PBA21702

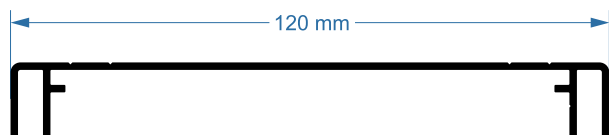

### SINGLE/DOUBLE SIDED LIGHTBOX 120 mm (PBA218N6)

Profile for acrylic lightboxes. Dimensions: 15 x 120 mm.

Code	Description	Sales unit
PBA218N6	Lightbox frame 15x120mm / mill aluminium	bar 6 m
PBA218L6	Lightbox frame 15x120 mm / white lacquered	bar 6 m
PBA21802	Mounting corner bracket profile 15x120mm (218)	unit
PBA21803	Extension plate for PBA218N6	unit
PBB10101	Reinforcement bracket lightbox crossbar (PBA218N0)	unit
ZFA125N6	Crossbar profile 25 x 12 mm, mill aluminium	bar 6 m
ZFA20LN6	Profile "L" 20x20mm, mill alu., banner crossbar for tubes	bar 6 m
PBB10096	Crossbar support angle PBA218, 96 mm	unit



PBA21802

# PLASTIC PROFILES

## LETTERS AND LIGHTBOXES

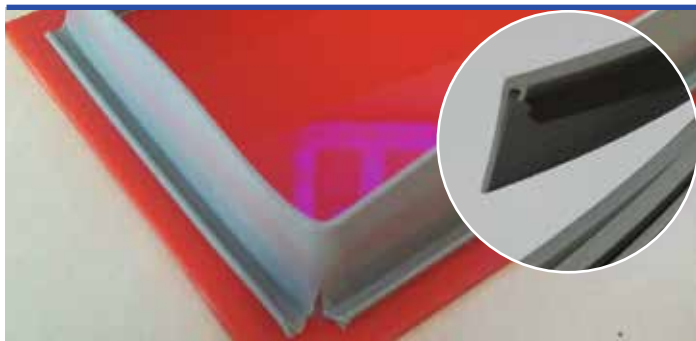

### PVC STRIP FOR CHANNEL LETTER FRONT

Flexible PVC profile for acrylic of any thickness. The strip is glued to the acrylic face and remains hidden inside the letter edge.

Code	Description
PPL20100	PVC strip for channel letters, grey, 100 m
PPL20111	PVC strip for channel letters, grey, 10 m



### "H" POLYCARBONATE PROFILE

Rigid transparent polycarbonate profile, "H"-shaped for joining acrylic, PVC, alu. composite sheets, etc. Sheet thickness: 3-4 mm. Dimensions: 20.5 x 8 mm.

Code	Description
PPL4H200	"H" polycarbonate profile for 3-4 mm sheets, 2 metres

### GLUED

Code	Spacing	Sales unit
GMD60320	20 mm	100 pcs.
GMD60324	24 mm	100 pcs.

### SCREWED

Code	Spacing	Sales unit
GMD60417	17 mm	100 pcs.
GMD60421	21 mm	100 pcs.

### STAND-OFF SUPPORTS

Spacers wall mounting of plates and channel letters. Formed by two parts.



GLUED

SCREW FIX

# PRELIGHT

## SHEET FRAME PROFILE

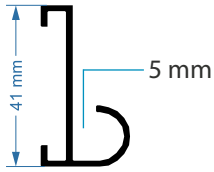

### SHEET FRAME PROFILE PPE6C6N6

For plates up to 5 mm thick.

Code	Description	Sales unit
PPE6C6N6	C-6 frame profile / mill aluminium	bar 6 m
PPE6C6L6	C-6 frame profile / white lacquered	bar 6 m
PPE6C602	Flat corner bracket / galvanised iron + 4 Allen screws	unit
PPL12605	1-bolt plate+nut / 30x35 mm	unit
PPE6C603	Extension plate for C6 frame profile	unit



PPE6C602



PPL12605



PPE6C603

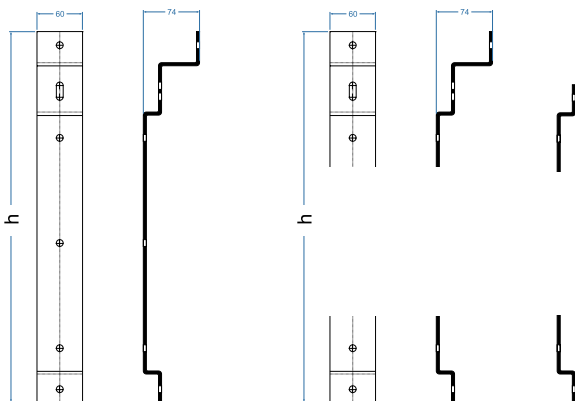

### BRACKETS

Frame brackets, with luminaire (70 cm)  
Frame brackets, in two pieces, adjustable height.

Code	Description	Sales unit
PSO22770	Standard bracket WITH luminaire / 70 cm	unit
PSO1295C	Upper bracket WITH luminaire	unit
PSO1295S	Bracket WITHOUT luminaire (upper/lower)	unit



\* To get a bracket without luminaire in 2 pieces, 2 units of PSO1295S are required.  
To get a bracket with luminaire in 2 pieces, 1 unit of PSO1295S plus 1 unit of PSO1295C are required.

# FRAMES

## SHEET FRAME PROFILE

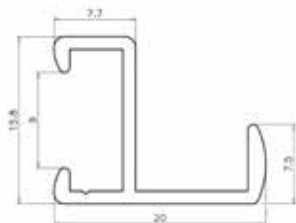

### PROFILES FOR SHEET FRAMING

Half-round shape.  
For rigid sheets up to 10 mm thick.  
Depth: 20 mm.

Code	Description	sales unit
PPL020N3	Sheet frame profile mill aluminium	Bar 3 m
PPL020A3	Sheet frame profile silver anodised	Bar 3 m
PPL020L3	Sheet frame profile white lacquered	Bar 3 m
PPL020K3	Sheet frame profile black lacquered	Bar 3 m
GMS24200	Accessory kit*	1
GMS24210	Hanger	1
GMS24230	Pressure spring	1
GMS24240	Double bracket with Allen screws	1

\* Accessory kit includes 4 brackets and 6 springs.

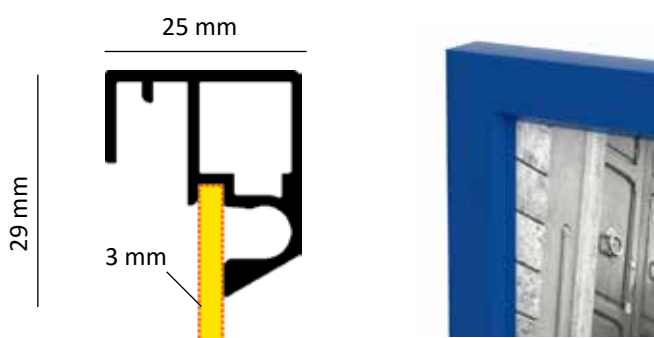

### Q2 VISIBLE ALUMINIUM FRAME PROFILE (NQ0002\_)

Visible aluminium frame profile.  
The Q2 profile can also be used to frame 3mm rigid panels.  
Tool-free assembly, with 4 plastic brackets.  
No tools required.  
Stock in 3m bars.  
25 x 29 mm.



P7-000EQ



NQ00EQAL

3m bars. Price per linear metre. Standard kits available in various sizes.

# FRAME JOINTS

FOR 30X30 AND 20x20 mm PROFILE



## FRAME JOINTS

Connectors for 30x30x2 mm and 20x20x1.5 mm square tubes. This avoids welding of frames or three-dimensional structures.



Description	Sales unit	BLACK	GREY
"L" joint for 30x30x2mm square tube	unit	PCTC30-L	PCTG30-L
"T" joint for 30x30x2mm square tube	unit	PCTC30-T	PCTG30-T
Longitudinal joint for 30x30x2mm square tube	unit	PCTC30-J	PCTG30-J
"X" joint for 30x30x2mm square tube	unit	PCTC30-X	-
Hidden "L" joint for 30x30x2mm square tube	unit	PCTC30-2	-
3-way joint for 30x30x2mm square tube	unit	PCTC30-3	PCTG30-3
4-way joint for 30x30x2mm square tube	unit	PCTC30-4	PCTG30-4
5-way joint for 30x30x2mm square tube	unit	PCTC30-5	-
6-way joint for 30x30x2mm square tube	unit	PCTC30-6	-
Cap for 30x30x2mm square tube	unit	PCTC-B30	PCTG-B30
"L" joint for 20x20x1.5mm square tube	unit	PCTC20-L	PCTG20-L
"T" joint for 20x20x1.5mm square tube	unit	PCTC20-T	PCTG20-T
Longitudinal joint for 20x20x1.5mm square tube	unit	PCTC20-J	PCTG20-J
"X" joint for 20x20x1.5mm square tube	unit	PCTC20-X	-
3-way joint for square tube 20x20x1,5mm	unit	PCTC20-3	PCTG20-3
4-way joint for square tube 20x20x1,5mm	unit	PCTC20-4	PCTG20-4
5-way joint for square tube 20x20x1,5mm	unit	PCTC20-5	-
6-way joint for square tube 20x20x1,5mm	unit	PCTC20-6	-
Cap for 20x20x1.5mm square tube	unit	PCTC-B20	PCTG-B20
Description	Sales unit	Mill AL.	Anodised
Square tube 30x30x2mm	bar 3.30 m	P7-00C33	P7-00A33
Square tube 20x20x1.5mm	bar 3.30 m	P7-00C20	P7-00A20

# FRAME JOINTS

FOR 30X30 AND 20x20 mm PROFILES



Longitudinal  
Joint



Joint  
in "L"



Joint  
in "T"



3D Joint  
3 ways



Joint  
in "X"



Joint  
hidden in "L"



3D Joint  
4 ways



3D Joint  
5 ways



3D Joint  
6 ways



End cap

Also available in grey



Square tube  
20 x 20 x 1,5 mm

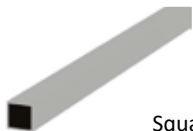

Square tube  
30 x 30 x 2 mm



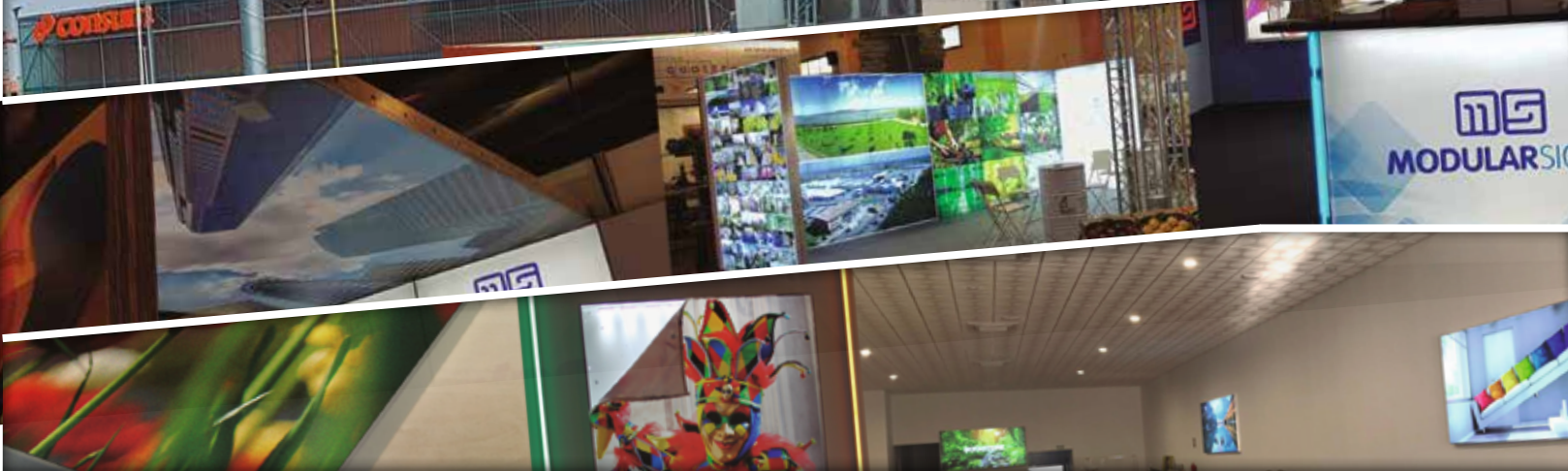



# Wayfinding signage

# GRAFOLIGHT SLALOM

## INTERCHANGEABLE SIGNAGE

*Grafolight Slalom. A smart system of curved panels for customizable signage with just a simple print. Fast to install, effortless to update. Built with slats, end caps, protective fronts and flag sign brackets, Slalom offers maximum flexibility. Mix and match its components to create elegant, dynamic directories that evolve with your needs.*



### SLALOM SLAT

Aluminium profile in 6 heights, 50 to 212 mm. Available in mill aluminium and silver anodised. 3.03 m bars.

Description	Sales unit	Mill alum.	Silver anod.
SLALOM slat 50 mm	l.m.	GLC722N0	GLC722AP
SLALOM slat 75 mm	l.m.	GLC723N0	GLC723AP
SLALOM slat 100 mm	l.m.	GLC724N0	GLC724AP
SLALOM slat 125 mm	l.m.	GLC725N0	GLC725AP
SLALOM slat 150 mm	l.m.	GLC726N0	GLC726AP
SLALOM slat 212 mm	l.m.	GLC727N0	GLC727AP



### SLALOM END CAP

ABS plastic cap for Slalom slats. Colours: black and grey. Screws not included.

### TRANSPARENT FRONT SHEET

Transparent PETG front sheet for Slalom slats. 2 m strips.

Description	Sales unit	BLACK	GREY
SLALOM curved cap, 50mm	unit *	GLT722SN	GLT722SG
SLALOM curved cap, 75mm	unit *	GLT723SN	GLT723SG
SLALOM curved cap, 100mm	unit *	GLT724SN	GLT724SG
SLALOM curved cap, 125mm	unit *	GLT725SN	GLT725SG
SLALOM curved cap, 150mm	unit *	GLT726SN	GLT726SG
SLALOM curved cap, 212mm	unit *	GLT727SN	GLT727SG

Code	Description	Sales unit
GLC75022	Transparent anti-glare sheet for SLALOM slat, 50 mm	l.m.
GLC75023	Transparent anti-glare sheet for SLALOM slat, 75 mm	l.m.
GLC75024	Transparent anti-glare sheet for SLALOM slat, 100 mm	l.m.
GLC75025	Transparent anti-glare sheet for SLALOM slat, 125 mm	l.m.
GLC75026	Transparent anti-glare sheet for SLALOM slat, 150 mm	l.m.
GLC75027	Transparent anti-glare sheet for SLALOM slat, 212 mm	l.m.

# GRAFOLIGHT SLALOM

## INTERCHANGEABLE SIGNAGE

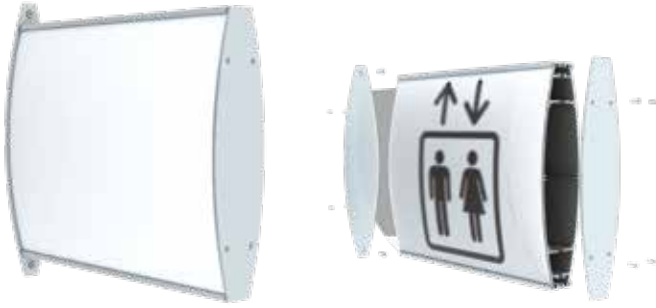

### SLALOM STAND-OFF BRACKET

Fixing brackets and end cap for SLALOM slats.  
It can also be suspended from the ceiling.  
In 5 heights, 75 to 212 mm.  
Available in silver anodised.  
Screws included.

Code	Description	Sales unit
GLT7423P	Slalom 2-slat cap, 75 mm, silver anodised	unit **
GLT7424P	Slalom 2-slat cap, 100 mm, silver anodised	unit **
GLT7425P	Slalom 2-slat cap, 125 mm, silver anodised	unit **
GLT7426P	Slalom 2-slat cap, 150 mm, silver anodised	unit **
GLT7427P	Slalom 2-slat cap, 212 mm, silver anodised	unit **
GLT7523P	Slalom 2-slat wall bracket, 75 mm, silver anodised	unit **
GLT7524P	Slalom 2-slat wall bracket, 100 mm, silver anodised	unit **
GLT7525P	Slalom 2-slat wall bracket, 125 mm, silver anodised	unit **
GLT7526P	Slalom 2-slat wall bracket, 150 mm, silver anodised	unit **
GLT7527P	Slalom 2-slat wall bracket, 212 mm, silver anodised	unit **

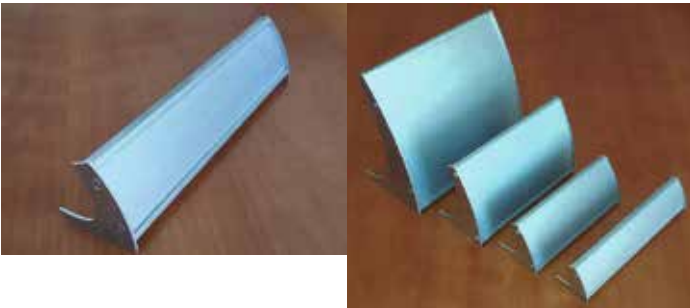

### DESK BRACKET

Desk Slalom slat bracket.  
In 4 heights: 50, 75, 125 and 212 mm.  
Available in silver anodised.  
Screws included.

Code	Description	Sales unit
GLT8022P	Set of 2 desk Slalom brackets, 50 mm, silver anod.	set
GLT8023P	Set of 2 desk Slalom brackets, 75 mm, silver anod.	set
GLT8025P	Set of 2 desk Slalom brackets, 125 mm, silver anod.	set
GLT8027P	Set of 2 desk Slalom brackets, 212 mm, silver anod.	set

3.03m aluminium bars. 2m transparent sheets. Price per linear metre.  
Custom cutting service.

\* Sold in boxes of 50 pcs. Surcharge for individual units.

\*\* Sold in boxes of 5 pcs. Surcharge for individual units.

# GRAFOLIGHT ELITE

## WAYFINDING SIGNAGE

*Grafolight Elite. Our modular wayfinding signage system for wall plaques, flag signs, directories and emergency signage. Designed to integrate seamlessly into any architectural environment, its exceptional adaptability and endless configurations make it suitable for virtually any application. A long-lasting range, ensuring consistency and continuity over time.*



### ELITE SLATS

Aluminium profile in 7 heights, 25 to 200 mm. Available in mill aluminium and silver anodised. 3.03 m bars.

Description	Sales unit	Mill alum.	Silver anod.
ELITE slat 25 mm	l.m.	GLA621N0	GLA621AP
ELITE slat 50 mm	l.m.	GLA622N0	GLA622AP
ELITE slat 75 mm	l.m.	GLA623N0	GLA623AP
ELITE slat 100 mm	l.m.	GLA624N0	GLA624AP
ELITE slat 125 mm	l.m.	GLA625N0	GLA625AP
ELITE slat 150 mm	l.m.	GLA626N0	GLA626AP
ELITE slat 200 mm	l.m.	GLA630N0	GLA630AP



### ELITE CAPS

ABS plastic caps, in black and grey. 200 mm cap in black lacquered aluminium. Screws not included.

Description	Sales unit	BLACK	GREY
ELITE NORMA straight cap, 25mm	unit *	GLT621NN	GLT621NG
ELITE NORMA straight cap, 50mm	unit *	GLT622NN	GLT622NG
ELITE NORMA straight cap, 75mm	unit *	GLT623NN	GLT623NG
ELITE NORMA straight cap, 100mm	unit *	GLT624NN	GLT624NG
ELITE NORMA straight cap, 125mm	unit *	GLT625NN	GLT625NG
ELITE NORMA straight cap, 150mm	unit *	GLT626NN	GLT626NG
ELITE NORMA straight cap, 200mm (metallic)	unit *	GLT630NN	-

# GRAFOLIGHT ELITE

## WAYFINDING SIGNAGE

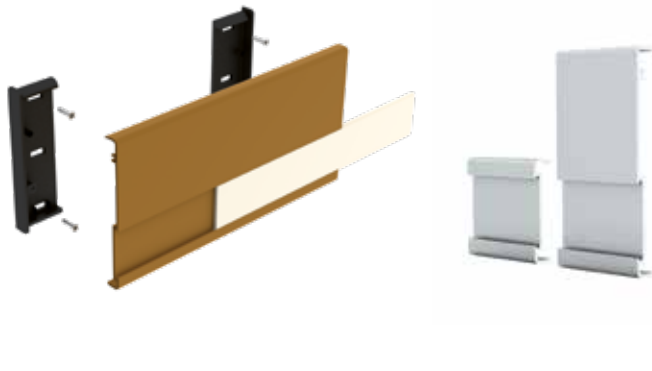

### BASE SLAT WITH SLIDING SLAT

Base slats of 50 and 100 mm. Sliding slat of 30 mm.



Description	Sales unit	Mill alum.	Silver anod.
ELITE base slat for sliding slat, 50mm	l.m.	GLA635N0	GLA635AP
ELITE base slat for sliding slat, 100mm	l.m.	GLA636N0	GLA636AP
ELITE sliding slat 30mm	l.m.	GLA637N0	GLA637AP



### ELITE STAND-OFF BRACKETS

Fixing brackets and end cap for ELITE slats.

Can also be suspended from the ceiling.

In 5 heights of 75, 100, 125, 150 and 200 mm.

Available in silver anodised.

Screws included.



Code	Description	Sales unit
GLT6423P	ELITE 2-slat cap, 75 mm, silver anodised	unit **
GLT6424P	ELITE 2-slat cap, 100 mm, silver anodised	unit **
GLT6425P	ELITE 2-slat cap, 125 mm, silver anodised	unit **
GLT6426P	ELITE 2-slat cap, 150 mm, silver anodised	unit **
GLT6430P	ELITE 2-slat cap, 200 mm, silver anodised	unit **
GLT6523P	ELITE 2-slat wall bracket, 75 mm, silver anodised	unit **
GLT6524P	ELITE 2-slat wall bracket, 100 mm, silver anodised	unit **
GLT6525P	ELITE 2-slat wall bracket, 125 mm, silver anodised	unit **
GLT6526P	ELITE 2-slat wall bracket, 150 mm, silver anodised	unit **
GLT6530P	ELITE 2-slat wall bracket, 200 mm, silver anodised	unit **

3.03m aluminium bars. Price per linear metre. Custom cutting service.

\* Sold in boxes of 50 pcs. Surcharge for individual units.

\*\* Sold in boxes of 5 pcs. Surcharge for individual units.

# GRAFOLIGHT ELITE

## WAYFINDING SIGNAGE

### FRAME ELEMENTS

The frame of a directory consists of the lateral frames, the upper and lower end slats and the corner caps.

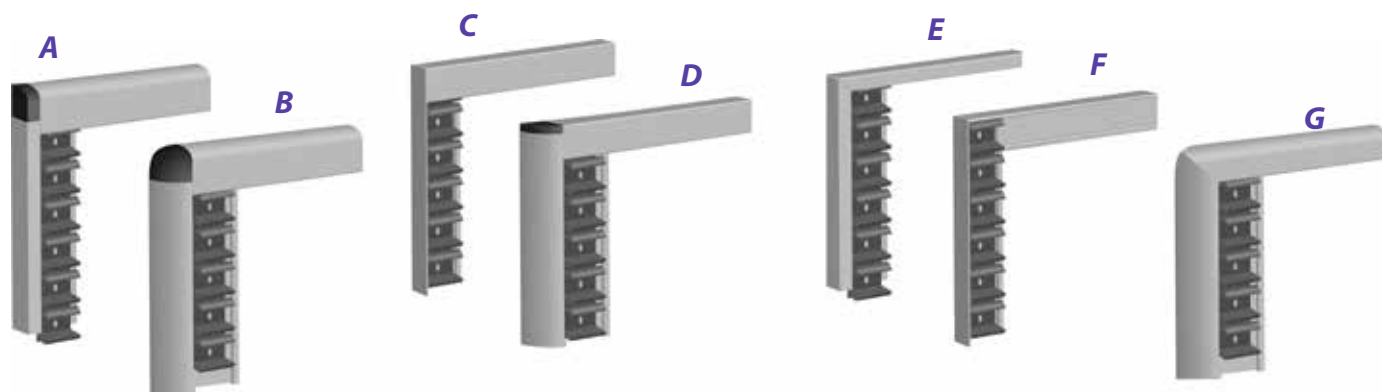

#### COMBINATIONS WITH FRAME AND END SLAT

A. Straight frame + Round end slat + cap GLT63RC\_

B. Round frame + Round end slat + cap GLT63CC\_

C. Flat frame + Straight end slat (no cap)

D. Round frame + Straight end slat + cap GLT63CR\_

#### COMBINATIONS WITH MITRE-CUT FRAME

E. Mitre-cut straight frame (no end slat or cap)

F. Mitre-cut flat frame (no end slat or cap)

G. Mitre-cut round frame (no end slat or cap)

Description	Sales unit	Mill alum.	Silver anod.	Black anod.
ELITE straight end slat 25mm	l.m.	GLA627N0	GLA627AP	-
ELITE round end slat 35mm	l.m.	GLA628N0	GLA628AP	-
ELITE flat frame	l.m.	GCP630N0	GCP630AP	GCP630AN
ELITE straight frame	l.m.	GCR631N0	GCR631AP	GCR631AN
ELITE round frame	l.m.	GCC632N0	GCC632AP	GCC632AN
ELITE round frame double sided	l.m.	GCC642N0	GCC642AP	GCC642AN

Description	Sales unit	BLACK	GREY
ELITE STRAIGHT frame cap - ROUND terminal	unit *	GLT63RCN	GLT63RCG
ELITE ROUND frame cap - STRAIGHT terminal	unit *	GLT63CRN	GLT63CRG
ELITE ROUND frame cap - ROUND terminal	unit *	GLT63CCN	GLT63CCG

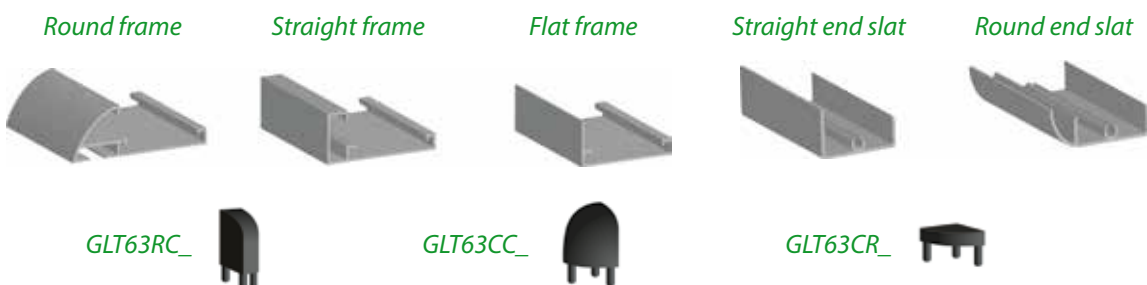

# GRAFOLIGHT ELITE

## WAYFINDING SIGNAGE



*Flat separator*

*Straight separator*

*Intermediate guide*

### INNER DIVIDERS

For vertical divisions within a directory, dividers (flat or straight) are used, where multi-clips are inserted. If the slat is very long, an intermediate guide can be added.

Description	Sales unit	Mill alum.	Silver anod.
ELITE multi-clip intermediate guide	l.m.	GCC633N0	-
ELITE double flat divider	l.m.	GCP640N0	GCP640AP
ELITE double straight divider	l.m.	GCR641N0	GCR641AP



### MULTI-CLIP

For slat fastening, plastic multi-clips are used, which can be cut to the exact size. Multi-clips are inserted into the guides of the lateral frames and dividers.

Code	Description	Sales unit
GLM63111	ELITE multi-clip 150 mm	unit **

3.03m aluminium bars. Price per linear metre. Custom cutting service.

\* Sold in boxes of 50 pcs. Surcharge for individual units.

\*\* Sold in boxes of 40 pcs. Surcharge for individual units.

# GRAFOLIGHT ELITE

## WAYFINDING SIGNAGE

### PANEL PROFILE SLAT

Directory composition is fully flexible.  
In addition to the standard Elite slats, there is the panel slat (to allow integrating a larger panel into the directory).

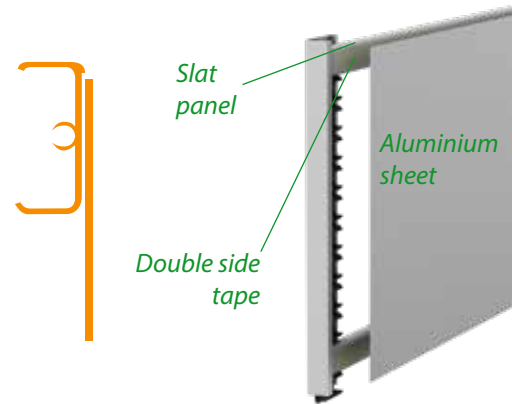

Description	Sales unit	Mill alum.	Silver anod.
ELITE panel slat	l.m.	GLA629N0	GLA629AP

### SUSPENDED DIRECTORIES

The frame of a suspended double-sided directory consists of the double-sided lateral frame, the upper and lower end slats and the caps. All elements are common to single-sided directories except the frame.



Description	Sales unit	Mill alum.	Silver anod.	Black anod.
Round frame 2 sides	l.m.	GCC642N0	GCC642AP	GCC642AN

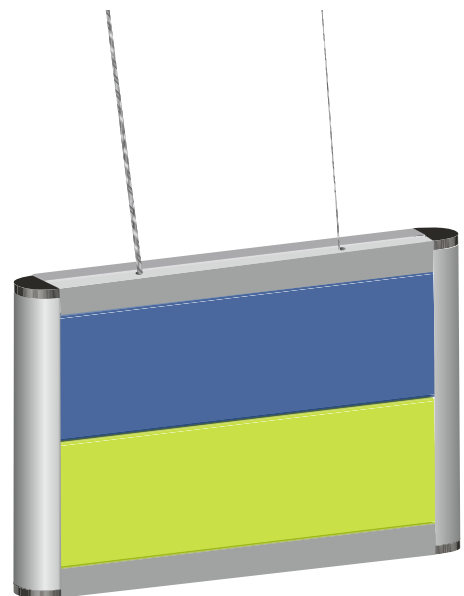





SSO

Modular Signs | Av. de España, 14 | E-30562 Ceutí (Murcia) | T +34 968 105 373  
[www.modular-signs.net](http://www.modular-signs.net) | [info@modular-signs.net](mailto:info@modular-signs.net)